



# SOLAR300 – SOLAR300N

User manual







**Table of contents:**

<b>1. PRECAUTIONS AND SAFETY MEASURES</b>	<b>4</b>
1.1. General	4
1.2. Preliminary instructions	4
1.3. During use	5
1.4. After use	5
1.5. Measuring (overvoltage) categories definitions	5
<b>2. GENERAL DESCRIPTION</b>	<b>6</b>
2.1. Introduction – PV and NPV systems	6
2.2. Functions	6
2.3. Initial screen	7
<b>3. PREPARE TO USE</b>	<b>7</b>
3.1. Initial check	7
3.2. Instrument power supply	7
3.3. Storage	7
<b>4. HOW TO OPERATE</b>	<b>8</b>
4.1. Instrument description	8
4.2. Keyboard description	9
4.3. Display description	10
4.4. Reset of meter	10
<b>5. GENERAL MENU</b>	<b>11</b>
5.1. General settings	12
5.1.1. Language selection	12
5.1.2. Date/Time settings	13
5.1.3. Display brightness adjust	13
5.1.4. Protection Password setting	14
5.1.5. Sound keys setting	15
5.1.6. Auto power off setting	15
5.1.7. Memory type setting	16
5.1.8. “Touch screen” calibration	16
5.2. Real Time Values	17
5.2.1. Single-MPPT photovoltaic system screen – Single-phase output	17
5.2.2. Single-MPPT photovoltaic system screen – Three-phase output	18
5.2.3. Screen of photovoltaic systems with multi-MPPT inverter (only with MPP300)	18
5.2.3.1. Multi-MPPT photovoltaic system screen – Single-phase output	19
5.2.3.2. Multi-MPPT photovoltaic system screen – Three-phase output	20
5.2.4. Value screens for NPV systems	20
5.2.4.1. Numerical screens sequence	21
5.2.5. SCOPE waveforms screens	24
5.2.6. HARM analysis screens	26
5.2.7. Vectorial diagrams screens	28
5.3. Analyzer Settings	30
5.3.1. Analyzer Configuration screen	30
5.3.1.1. Setting system frequency	34
5.3.1.2. Setting clamp type	35
5.3.1.3. Setting full scale of clamps	35
5.3.1.4. Setting VT ratio	36
5.3.2. Parameter setting screen – PV systems	37
5.3.2.1. Setting the nominal power of the photovoltaic system	37
5.3.2.2. Setting the Gamma parameter of photovoltaic panels	37
5.3.2.3. Setting the NOCT parameter of photovoltaic panels	38
5.3.2.4. Setting temperatures Tenv and Tpv	38
5.3.2.5. DC input N setting (only together with opt. MPP300)	38
5.3.2.6. Selection of the relationship for Temperature effects compensations	39
5.3.3. Advanced setting screen – PV systems	40
5.3.3.1. Setting of remote unit	40
5.3.3.2. Setting the corrective factor of the pyranometer (only for SOLAR-01 unit)	40
5.3.3.3. Setting of minimum irradiance threshold	41
5.3.3.4. Setting of corrective constant of DC clamp	41
5.3.4. Advanced Settings screen – NPV systems	42
5.3.4.1. Zoom graphics option	42

5.3.4.2.	Harmonics type option.....	43
5.3.4.3.	Harmonics values option.....	43
5.3.4.4.	Zoom with respect to the 1st harmonic option.....	44
5.3.4.5.	Average value option.....	44
5.4.	Recording settings.....	45
5.4.1.	Recorder setting screen – PV systems.....	45
5.4.1.1.	Item Comments.....	46
5.4.1.2.	Use of the virtual keyboard.....	46
5.4.1.3.	Items Start and Stop.....	47
5.4.1.4.	Item Integration period.....	47
5.4.1.5.	Item General Parameters for use with SOLAR01 or SOLAR02 units.....	47
5.4.1.6.	Description of the sub-levels of item General Parameters.....	49
5.4.1.7.	Item SOLAR-01 and SOLAR-02.....	50
5.4.1.8.	Default settings.....	50
5.4.1.9.	Item General Parameters for use with MPP300 unit.....	52
5.4.2.	Recording settings screen – NPV systems.....	53
5.4.2.1.	Comments.....	53
5.4.2.2.	Use of virtual keyboard.....	54
5.4.2.3.	Start and Stop.....	54
5.4.2.4.	Integration period.....	55
5.4.2.5.	Cogenerations.....	55
5.4.2.6.	General Parameters.....	56
5.4.2.7.	General Parameters: sub-levels description.....	58
5.4.2.8.	Harmonics: sub-levels description.....	59
5.4.2.9.	Voltage Anomalies.....	60
5.4.2.10.	Inrush current.....	62
5.4.2.11.	Flicker.....	63
5.4.2.12.	Unbalance.....	64
5.4.2.13.	Spike.....	64
5.4.2.14.	Predefined configurations.....	65
5.5.	Start a test on PV system.....	73
5.5.1.	While testing.....	75
5.5.2.	Stop a test.....	76
5.6.	Start a recording.....	77
5.6.1.	Recording settings screen – NPV systems (only for NPV systems).....	80
5.6.2.	During a recording.....	81
5.7.	Saved data management section.....	83
5.7.1.	Recording analysis (Reg type).....	84
5.7.1.1.	Recording information.....	84
5.7.1.2.	Recording graph.....	85
5.7.1.3.	Dips and swells.....	87
5.7.1.4.	Spikes (Transients).....	88
5.7.1.5.	Inrush currents.....	90
5.7.1.6.	EN50160.....	92
5.7.1.7.	Analysis of consumed energy.....	94
5.7.1.8.	Analysis of produced energy.....	95
5.7.2.	Recording analysis (RegPV type).....	96
5.7.2.1.	Recording information.....	96
5.7.2.2.	Result for data of RecPV type.....	97
5.7.2.3.	Result for data of RecMPP type.....	99
5.7.2.4.	Recording graph.....	100
5.7.3.	Recording analysis (Istant type).....	102
5.7.3.1.	Recording information.....	102
5.7.3.2.	Graph.....	103
5.7.3.3.	Harmonics analysis.....	103
5.7.3.4.	Vectors.....	104
5.7.3.5.	Measures.....	105
5.7.4.	Transfer recordings to a external Pen Driver USB.....	106
5.7.5.	Saving recordings to external Compact Flash.....	107
5.8.	Meter information.....	108
6.	<b>CONNECTION OF METER TO PC (WIN XP).....</b>	<b>109</b>
7.	<b>MEASURING PROCEDURES.....</b>	<b>110</b>
7.1.	Test/Recording of PV-1 system with remote unit SOLAR-01.....	111
7.2.	Test/Recording of PV-1 system with remote unit SOLAR-02.....	113
7.3.	Test/Recording of PV-3 system with remote unit SOLAR-01.....	115



7.4. Test/Recording of PV-3 system with remote unit SOLAR-02 .....	117
7.5. Test/Recording of PV with MPPT – Single/three phase AC .....	119
7.6. Using the meter in a Single phase system .....	125
7.7. Using the meter in a Three phase 4 wire system .....	126
7.8. Using the meter in a Three phase 3 wire system .....	127
7.9. Using of meter in a Three phase 3 wire ARON system .....	128
7.10. Using of meter in a 3-phase 4-wire 3PHL (USA system) .....	129
7.11. Using of meter in a 3-phase 3-wire 3POD (USA system) .....	130
7.12. Using of meter in a 3 wire 3P2E (USA system) .....	131
7.13. Using of meter in a 3 wire 3POY (USA system) .....	132
7.14. Using of meter in a 3 wire 1PH3W (USA system) .....	133
<b>8. MAINTENANCE .....</b>	<b>134</b>
8.1. General .....	134
8.2. Situations relative to led of SOLAR-01 unit .....	134
8.2.1. Replacement battery of SOLAR-01 and SOLAR-02 .....	134
8.3. Situations relative to internal battery of instrument .....	134
8.4. Cleaning .....	135
8.5. End of life .....	135
<b>9. TECHNICAL SPECIFICATIONS .....</b>	<b>136</b>
9.1. Technical features .....	136
9.2. General features .....	139
9.3. Environment .....	139
9.4. Accessories .....	139
<b>10. APPENDIX – THEORETICAL OUTLINES .....</b>	<b>140</b>
10.1. Testing PV systems .....	140
10.2. Recording on PV systems .....	141
10.3. Notes on MPPT (Maximum Power Point Tracker) .....	142
10.4. Voltage Anomalies .....	143
10.5. Voltage and current Harmonics .....	144
10.5.1. Theory .....	144
10.5.2. Limit values for harmonic voltage .....	145
10.5.3. Presence of harmonics: causes .....	145
10.5.4. Presence of harmonics: consequences .....	146
10.6. Inrush currents .....	147
10.7. Flicker .....	148
10.8. Supply voltage unbalance .....	149
10.9. Voltage fast transients (spikes) .....	150
10.10. Power and power factor: definitions .....	152
10.10.1. Conventions on powers and power factors .....	153
10.10.2. Three phase 3 wire ARON system .....	154
10.11. Measuring method: outlines .....	155
10.11.1. Integration period .....	155
10.11.2. Power factor calculations .....	155
<b>11. AFTER-SALE SERVICE .....</b>	<b>156</b>
11.1. Warranty .....	156
11.2. Service .....	156

## 1. PRECAUTIONS AND SAFETY MEASURES

### 1.1. GENERAL

This meter has been designed in compliance to IEC/EN61010-1 directive. For your own safety and to avoid damaging the instrument we suggest you follow the procedures hereby prescribed and to read carefully all the notes preceded by the symbol 

Before and during measurements please take care of below points:

- The instrument consists in a main unit **SOLAR300** or **SOLAR300N** and a remote unit for acquisition (**SOLAR-01** or **SOLAR-02** generically called "SOLAR-0x except notation specifically indicated"). If not otherwise indicated, all safety instructions are intended as always referred to the main unit.
- Do not measure voltage or current in wet or dusty places.
- Do not measure in presence of gas, explosive materials or combustibles.
- Do not touch the circuit under test if no measurement is being taken.
- Do not touch exposed metal parts, unused terminals, circuits and so on.
- Do not use the meter if it seems to be malfunctioning (i.e. if you notice deformations, breaks, leakage of substances, absence of messages on the display and so on).

The below symbols are used in this manual and on meter:



Caution: keep to what prescribed by the manual. An incorrect use could damage the instrument or its components



High voltage: risk of electric shock



Double insulation



The voltages indicates on the left of this symbol are referred to ground

### 1.2. PRELIMINARY INSTRUCTIONS

- This instrument has been designed for use in places with pollution class 2.
- It can be used for **VOLTAGE** and **CURRENT** measurements on installations of excess voltage CAT IV 600V to earth and a 1000V maximum voltage between inputs.
- Please keep to the usual safety standards aimed at protecting against dangerous currents and protecting the instrument against incorrect operations.
- Only the accessories supplied with the instrument guarantee compliance with the safety standards. Accordingly, they must be in good conditions and, if necessary, they must be replaced with identical models.
- Do not take measurements on circuits exceeding the specified current and voltage limits.
- Before connecting cables, crocodiles and clamps to the circuit under test, make sure that the right function has been selected.

#### CAUTION



- Please perform a complete charging of internal battery for at least 5 hours before using the meter the first time.
- Please press and hold the **ON/OFF** key for about 5s when turning on the meter the first time.



### 1.3. DURING USE

Please read carefully the below points:



#### CAUTION

- Should you fail to keep to the prescribed instructions you could damage the instrument and/or its components or endanger your safety
- Do not touch any unused terminal when the meter is connected to the circuit on test
- When measuring current, other currents located near the leads may affect the measuring accuracy
- When measuring current, always position the wire in the very middle of the jaws in order to obtain the highest accuracy
- A measured value remains constant if the "HOLD" function is active. Should you notice that the measured value remains unchanged, disable the "HOLD" function

### 1.4. AFTER USE

- After use, turn off the instrument by pressing **ON/OFF** key for a few seconds.
- If you expect not to use the instrument for a long time please keep to the storage instructions described at § 3.3.

### 1.5. MEASURING (OVERVOLTAGE) CATEGORIES DEFINITIONS

IEC/EN61010-1: Safety requirements for electrical equipment for measurement, control and laboratory use, Part 1: General requirements, gives a definition of measuring category, usually called overvoltage category. § 6.7.4: Measuring circuits:

(OMISSIS)

Circuits are divided into the following measurement categories:

- **Measurement category IV** is for measurements performed at the source of the low-voltage installation  
*Examples are electricity meters and measurements on primary overcurrent protection devices and ripple control units*
- **Measurement category III** is for measurements performed in the building installation.  
*Examples are measurements on distribution boards, circuit breakers, wiring, including cables, bus-bars, junction boxes, switches, socket-outlets in the fixed installation, and equipment for industrial use and some other equipment, for example, stationary motors with permanent connection to fixed installation*
- **Measurement category II** is for measurements performed on circuits directly connected to the low voltage installation  
*Examples are measurements on household appliances, portable tools and similar equipment*
- **Measurement category I** is for measurements performed on circuits not directly connected to MAINS  
*Examples are measurements on circuits not derived from MAINS, and specially protected (internal) MAINS-derived circuits. In the latter case, transient stresses are variable; for that reason, the norm requires that the transient withstand capability of the equipment is made known to the user*

## 2. GENERAL DESCRIPTION

### 2.1. Introduction – PV and NPV systems

The instrument allows a totally new approach to the measuring world when dealing with photovoltaic systems and mains analyses on single-phase and three-phase electrical systems; the combination between instruments provided with microprocessor and the Windows CE technology allows analyzing a huge amount of data in such a simple and quick way as with no other system available.

Further in this manual, the following acronyms will be used:

- **PV systems:** Single-phase and three-phase photovoltaic systems.
- **NPV systems:** Single-phase and three-phase non-photovoltaic electrical systems.
- **MPPT:** Maximum Power Point Tracker (see § 10.3)

### CAUTION



This manual covers two models: SOLAR300 and SOLAR300N. In this manual, these models will be generically referred to as the "instrument". **In general, whenever one of the following topics is dealt with:**

- ✓ Flicker (Pst, Plt)
- ✓ Starting current / inrush current measurement
- ✓ Analysis of fast transients on voltages (spikes)
- ✓ EN50160 analysis (performed by the instrument)
- ✓ Use of the accessory MPP300

**this is to be considered (even if not expressly indicated) as referred to model SOLAR300N only**

### 2.2. FUNCTIONS

This meter is able to perform:

- ✓ Real-time display of the values of the electrical and environmental quantities (irradiation, temperature) of a photovoltaic system for generating single-phase or three-phase electric power.
- ✓ Calculation of the values regarding the maximum efficiency point.
- ✓ Real-time display of the values of each electric quantity of a single-phase and three-phase, 3-wire or 4-wire system, harmonic analysis of voltages and currents up to the 49<sup>th</sup> harmonic, voltage anomalies (dips and peaks) with 10ms resolution, Flicker (Pst, Plt) display of the parameters of the unbalance on voltages, inrush current routines and voltage spikes with 5 $\mu$ s resolution
- ✓ Real time display of any input signal waveform, histogram graphics of harmonics analysis and vectorial diagrams of mutual angles between voltages and currents.
- ✓ Recording (saving the values of the electric quantities over time in the instrument's memory) the values of the electrical and environmental quantities (irradiation, temperature) of a photovoltaic system for generating single-phase or three-phase electric power.
- ✓ Recording (saving the values of the electric quantities over time in the instrument's memory) of this values: TRMS values of voltages, currents, corresponding harmonics, Flicker active, reactive and apparent powers, power factors and cosphi, active, reactive and apparent energies, voltage anomalies.
- ✓ Saving (by pressing **SAVE** key) of a "**Instant**" sampled of instantaneous values of any parameters present at instrument input inside memory.



### 2.3. INITIAL SCREEN

When turning on the instrument by pressing **ON/OFF** key, this below screen will appear for a few seconds:

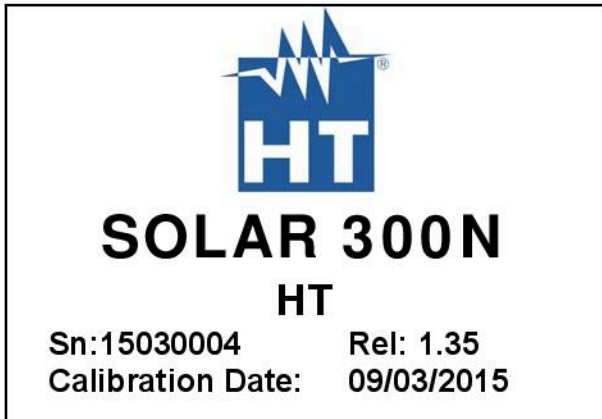

Here you can see (besides model code and manufacturer name):

- The serial number of the meter (Sn)
- The release of internal meter Firmware (Rel.:
- Date of last calibration (Calibration Date:)

### 3. PREPARE TO USE

#### 3.1. INITIAL CHECK

This meter has been checked before shipment from an electrical and mechanical point of view. All possible precautions have been taken in order to deliver it in perfect condition. Notwithstanding, on receipt of the instrument we suggest that you check it summarily to make sure that no damage has occurred in transit. Should you find irregularities please contact the carrier immediately. Furthermore, please make sure that the parcel contains all the accessories and parts listed at enclosed packing list. In case of discrepancies please contact your dealer. Should it be necessary to return the instrument to the supplier please keep to the instructions given at § 11.

#### 3.2. INSTRUMENT POWER SUPPLY

The instrument can be powered only by a rechargeable Li-ION battery (3.7V, 1900mAh) which is included with the meter. Use only the external adapter standard supplied with meter for charging battery (see § 8.3).



#### CAUTION

- For recordings use **ALWAYS** the external adapter (even the instrument allows the operator to perform a recording using internal battery)
- **Please perform a complete charging of internal battery for at least 5 hours before the first use of meter**

The meter uses the below options to increase the battery duration:

- ✓ Automatically reduction of display brightness after about 30s from last operation performed with meter, with external adapter not connected.
- ✓ Auto Power OFF feature after about 5 minutes from the last operation on function keys or display touch screen with external adapter not connected (see § 5.1.6)

#### 3.3. STORAGE

To guarantee accurate measurements, after a long storage period in severe environmental conditions wait until the instrument resumes its normal conditions (see § 9.3).



## 4. HOW TO OPERATE

### 4.1. INSTRUMENT DESCRIPTION

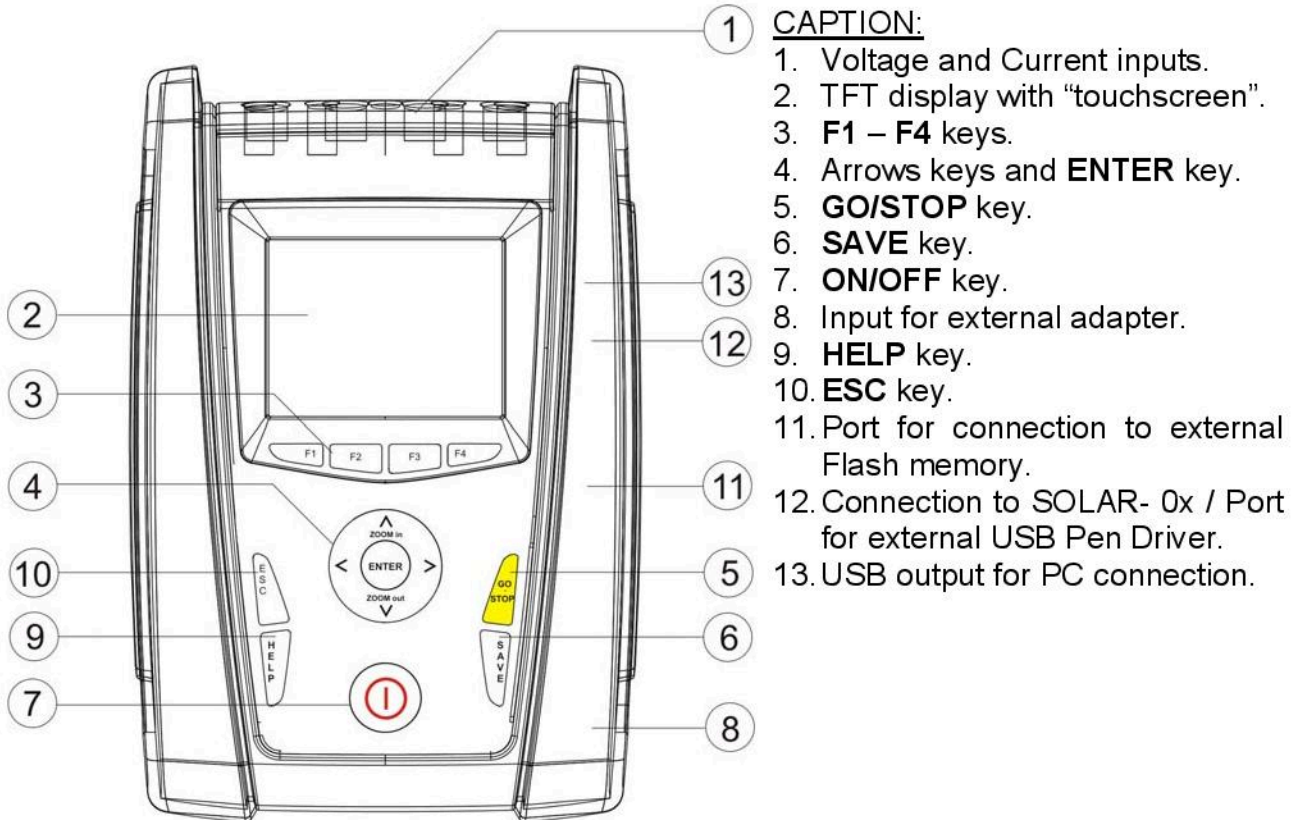

Fig. 1: Description of meter's front panel

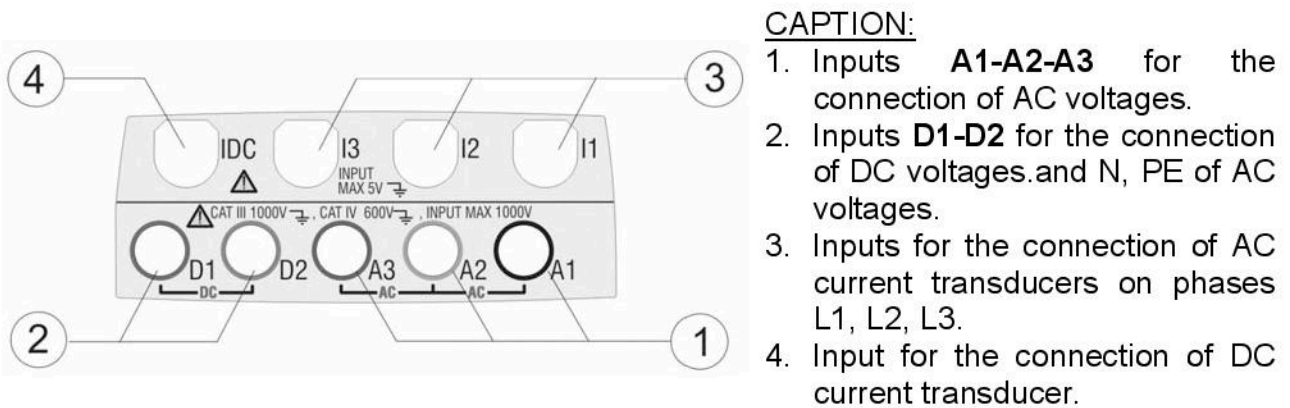

Fig. 2: Description of meter's input terminals

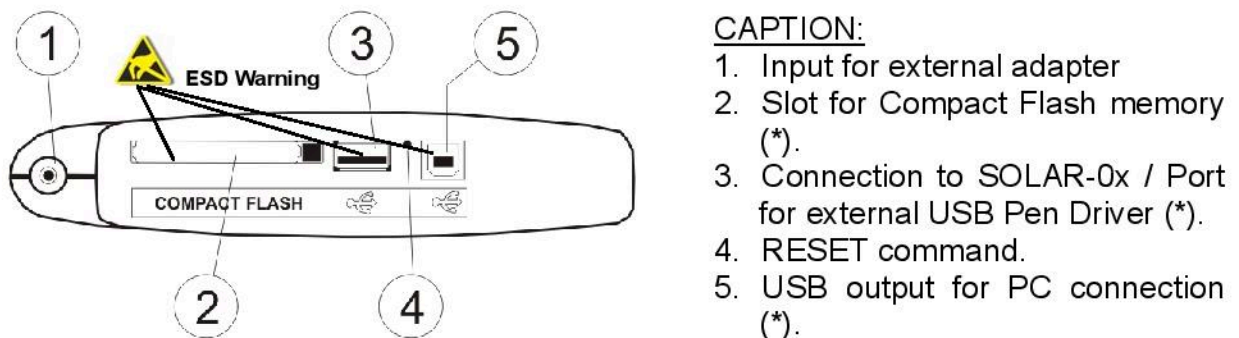



Fig. 3: Description of meter's output connectors

(\*) Use the output connectors included into the lateral side only with meter OFF. This outputs should be interested by electrostatic discharges (ESD).

## 4.2. KEYBOARD DESCRIPTION

The below keys are available:

- ☞ Key **ON/OFF**: press this key to turn on the meter. Press and hold the key for few seconds to turn off the meter.
- ☞ Keys **F1, F2, F3, F4**: multifunction keys. The various functions are intended from the s shown on the bottom of display.
- ☞ Key **ESC**: to leave a menu or a sub-menu. The smart icon  which is shown on screens performs the same function under interactive mode.
- ☞ Key **ENTER**: double function key:
  - ✓ **ENTER**: to confirm the settings made
  - ✓ **HOLD**: to block the value updating in all real time screens and also during a recording operation. "H" symbol is shown at display by any pressing of key as for Fig. 4:

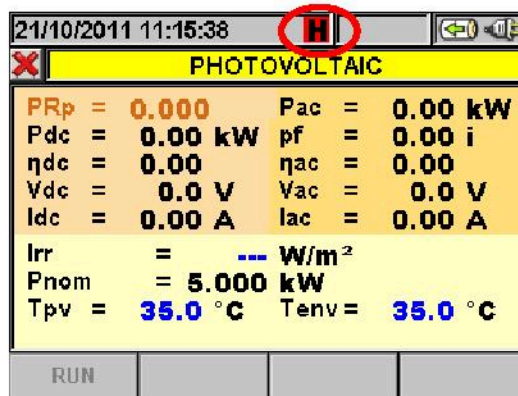



Fig. 4: HOLD function active at display

- ☞ Keys **◀, ▲, ▶, ▼/ZOOM in/ZOOM out**: these arrows keys permit to select the desired programmable parameters inside various screens. The double function of **ZOOM in** and **ZOOM out** permits to change manually the full scale of some graphics inside SCOPE section in order to improve the global resolution on viewing waveforms of signals (see § 5.3.2.5). Arrow keys **◀** and **▶** permit to operate on internal pages inside some kinds of screen.
- ☞ Key **SAVE**: saves an "Instant" type sampling of instantaneous values in internal memory (see § 5.7). The same key permits also the saving of various settings inside screens. The smart icon  which is shown on screens perform the same function under interactive mode.
- ☞ Key **GO/STOP**: permits to start/stop any recording (see § 5.6).
- ☞ Key **HELP**: opens an help on line window on the meter screen with a short description of the same screen which is instantaneously shown. This key is active for any function.

### 4.3. DISPLAY DESCRIPTION

The display is a graphic TFT colour type, 73x57mm sizes (VGA 320x240 pxls) with “touch-screen” which permits a really easy operations using standard PT400 pointer pen fitted in lateral side of meter.

On first display's row the system date/hour is shown by meter (see § 5.1.2 for settings). There are also some icons relative to battery level indication or external adapter fitted and for waiting and start of a recording. On second row the kind of selected measure is shown and the last row shows the short s associated to **F1**, **F4** function keys. An example of possible screen is shown on (see Fig. 5):

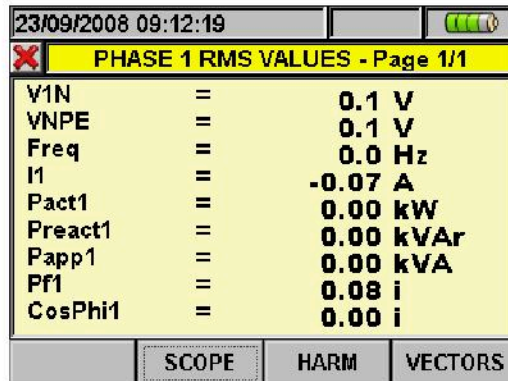

23/09/2008 09:12:19		
X PHASE 1 RMS VALUES - Page 1/1		
V1N	=	0.1 V
VNPE	=	0.1 V
Freq	=	0.0 Hz
I1	=	-0.07 A
Pact1	=	0.00 kW
Preact1	=	0.00 kVAr
Papp1	=	0.00 kVA
Pf1	=	0.08 i
CosPhi1	=	0.00 i
SCOPE		HARM
		VECTORS

Fig. 5: Example of screen

### 4.4. RESET OF METER

The meter is designed with internal Reset Hardware which can be used if any functions is blocked at display, in order to restore all correct operations. Consider the below steps to perform Reset actions:

1. Using the PT400 pointer pen or another object softly pressing the internal part of the little hole which is present on the lateral side of meter (see Fig. 3 – Fig. 4). The meter goes automatically off.
2. Turn on the meter by pressing **ON/OFF** key and verify the correct working.

RESET operation **will not** erase the meter's internal memory.



## 5. GENERAL MENU

Whenever you turn on the meter, the below “Analyzer Configuration” screen is shown, relative to the last configuration used (see Fig. 6):

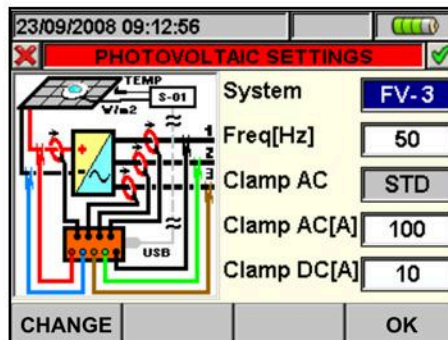

Fig. 6: Example of analyzer configuration

In this situation the user can decide whether modify the actual configuration by pressing **F1** key (or “CHANGE” at display – see § 5.3.1) or directly access to General Menu by pressing **F4** key (or the “OK” at display). If no action is performed within 10s the meter automatically goes to GENERAL MENU screen.

The GENERAL MENU of meter is correspondent to the screen shown in (see Fig. 7):

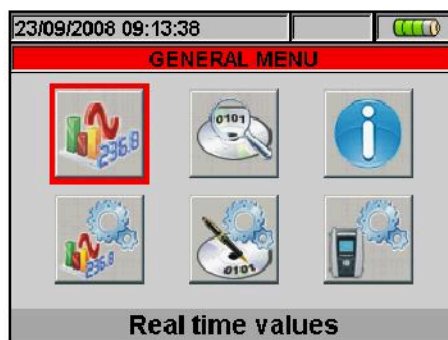

Fig. 7: GENERAL MENU screen

The actual selected section is shown with red background at display and it's title is shown in the bottom of display. The below sections are available on meter:

- **General settings** section which permits to set the system parameters of meter as date/hour, language, display brightness, protection password, keys sound on pressure auto power off and memory type (see § 5.1).
- **Real time values** section which permits to see the real time measured values at display under various formats (see § 5.2).
- **Analyzer settings** section which permits to define the simple and advanced configurations relative to connection of meter to the installation (see § 5.3).
- **Recorder settings** section which permits to select the parameters for each recording and see the information about the autonomy of meter during operation (see § 5.4).
- **Recording results** section which permits to see the list of all recordings saved on internal memory, for memory cancel operations and the transfer of data in external Pen Driver USB (see § 5.7).
- **Meter information** section which permits to access to general information about meter (serial number, internal Firmware and Software release, etc...) (see § 5.8).

## 5.1. GENERAL SETTINGS

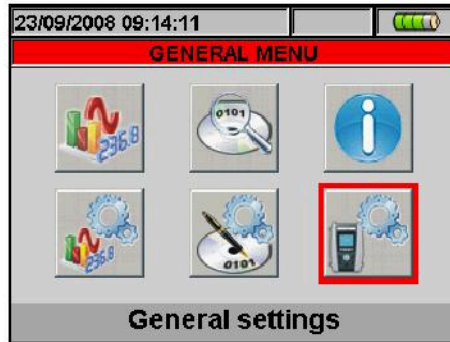

Fig. 8: MENU GENERAL screen - General settings section

This section permits to set the below control parameters:

- System language
- System Date/Hour
- Display brightness
- Protection password during recordings
- Key sound on pressure
- Auto Power OFF Enable/Disable
- Type of memory in which to save the recordings
- Perform “touch screen” display calibration (TOUCH)

Pressing **ENTER** key (or touch the relative icon at display). The below screen is shown by meter:

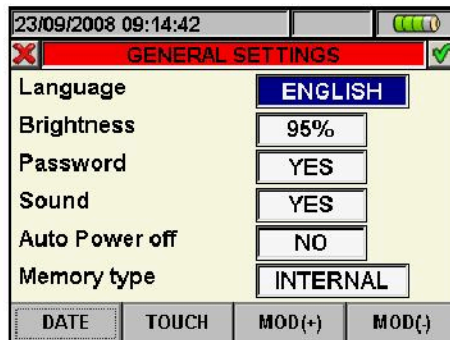



Fig. 9: General Settings screen

### 5.1.1. Language selection

1. Move the cursor using arrows keys on field relative to “Language”, marked with blue background.
2. Using **F3** or **F4** keys (or touch **MOD(+)** o **MOD(-)**) for selection of language choosing among the different options.
3. Pressing **SAVE** or **ENTER** keys (or the smart icon ) to save the selected option and confirm by “Ok”. This selected parameter will be present also the turning off of meter.
4. Pressing **ESC** key (or the smart icon ) to exit by screen without saving any modify.

### 5.1.2. Date/Time settings

1. Press the **F1** key (or touch **DATE** at display) on screen of Fig. 9. The below screen is shown by meter:

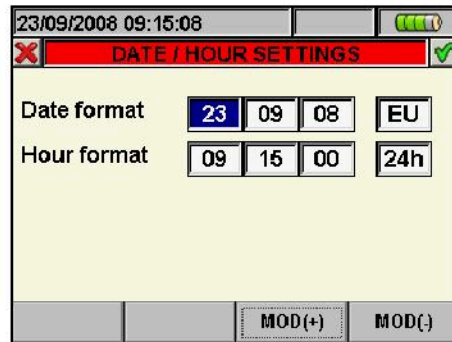

Fig. 10: Date/Time settings screen

2. Move the cursor using arrows keys on field relative to "Date format" and "Time format", marked with blue background.
3. Using **F3** or **F4** keys (or touch **MOD(+)** o **MOD(-)**) for Date setting choosing between the two possible formats (European EU or American US):

<b>DD:MM:YY</b>	Option EU
<b>MM:DD:YY</b>	Option US

4. Using **F3** or **F4** keys (alternatively touch **MOD(+)** o **MOD(-)**) for Time setting choosing between two possible format (24 hours or 12 hours):

<b>HH:MM:SS</b>	Option 24h
<b>HH:MM:AM(PM)</b>	Option 12h

5. Press **SAVE** or **ENTER** keys (or the smart icon ) to save the selected option and confirm by "Ok". This selected parameter will be present also the turning off of meter.
6. Pressing **ESC** key (or the smart icon ) to exit by screen without saving any modify.

### 5.1.3. Display brightness adjust

1. Move the cursor using arrows keys on the field relative to "Brightness", marked with blue background:

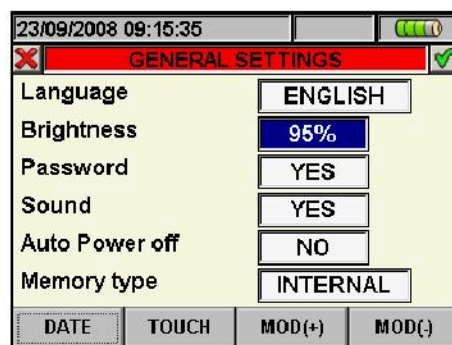

Fig. 11: Adjust brightness screen

2. Using **F3** or **F4** keys (alternatively touch **MOD(+)** o **MOD(-)**) for adjustment of display brightness percentage. The meter increases or decreases this value in step of 5% for each pressure of key.
3. Press **SAVE** or **ENTER** key (or the smart icon ) to save the selected option and confirm by "Ok". This selected parameter will be present also the turn off of meter.
4. Press **ESC** key (or the smart icon ) to quit without saving any modification.



#### 5.1.4. Protection Password setting

The meter is provided with a protection password to avoid the risk of accidental recording interruption.

1. Move the cursor using arrows keys on field relative to "Password" , marked it with blue background:

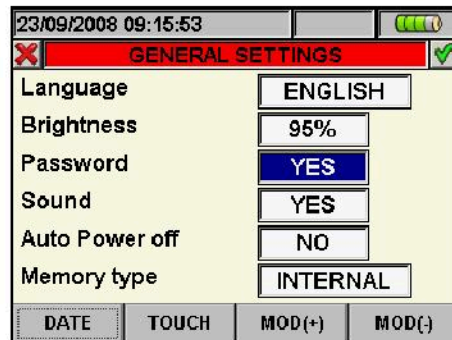

Fig. 12: Protection password settings screen

2. Use **F3** or **F4** keys (alternatively touch **MOD(+)** o **MOD(-)**) to enable "YES" or disable "NO" of Password.
3. With Password enabled, should **GO/STOP** key be pressed during a recording, the meter will not stop the operation but will require the user to insert password as shown in the below screen:

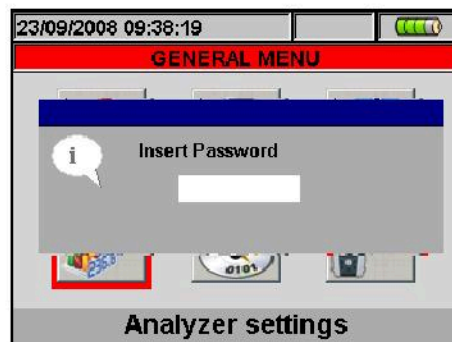



Fig. 13: Insert Password screen

4. The fixed password (**not changeable by user**) to insert on meter within 10s from warning message is the below sequence of keys:

<b>F1, F4, F3, F2</b>
-----------------------

5. If a wrong password is fitted or if more of 10s elapse, the meter will give the warning message "Wrong Password" and it's necessary to repeat the operation. As soon as the correct password is fitted, the meter will stop immediately the recording running and the correspondent icon at display (see Fig. 13) will disappear.
6. Press **SAVE** or **ENTER** keys (or the smart icon ) to save the selected option and confirm by "Ok". This selected parameter will be present also after turning off the meter.
7. Pressing **ESC** key (or the smart icon ) to quit without saving any modification.



### 5.1.5. Sound keys setting

The meter permits to enable a instantaneous sound for any key pressure of the frontal panel.

1. Move the cursor using arrows keys on field relative to "Sound", marked with blue background:

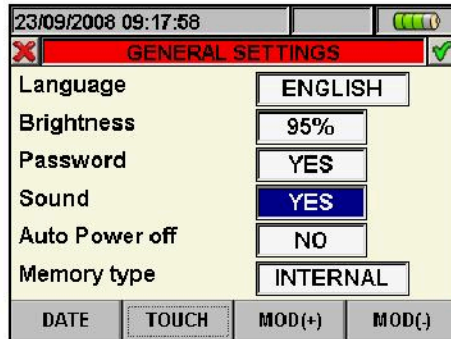



Fig. 14: Keys sound settings screen

2. Use **F3** or **F4** keys (alternatively touch **MOD(+)** o **MOD(-)**) to enable "YES" or disable "NO" of keys sound.
3. Pressing **SAVE** or **ENTER** keys (or the smart icon ) to save the selected option and confirm by "OK". This selected parameter will be present also after turning off the meter.
4. Press **ESC** key (or the smart icon ) to quit without saving any modification.

### 5.1.6. Auto power off setting

The meter permits to enable or disable the auto power off option in order to prevent a quick discharge of internal battery. This feature, if selected, is active under each of the following conditions:

- No action was performed both any key or touch display for at least **5 minutes**.
- Meter does not supplied with the external adapter.
- Meter does not in recording running.

The effect is a long sound before turn off of meter.

1. Move the cursor using arrows keys on the field relative to "Auto power off", marked with blue background:

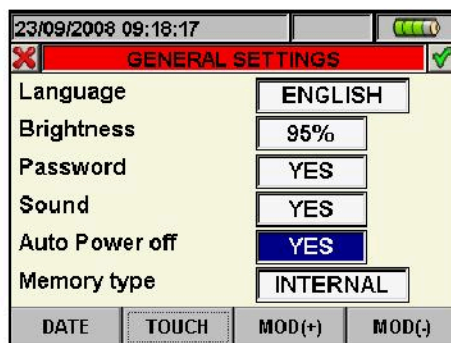



Fig. 15: Auto power off setting screen

2. Use **F3** or **F4** keys (alternatively touch **MOD(+)** o **MOD(-)**) for enable "YES" or disable "NO" auto power off.
3. Press **SAVE** or **ENTER** keys (or the smart icon ) to save the selected option and confirm by "OK". This selected parameter will be present also after turning off the meter.
4. Press **ESC** key (or the smart icon ) to quit without saving any modification.

### 5.1.7. Memory type setting

The meter permits saving of recordings both in its internal memory (about 15Mbytes) and by using an external compact flash (see § 5.7.5 for details) fitted (see Fig. 3). Regardless of the capacity of the memory inserted, the maximum size of a recording is set to 32Mbytes. A Compact Flash memory of higher capacity will therefore be able to contain a high number of recordings, each one of which will have a maximum size of 32Mbytes. For the selection of memory type follow the below steps:

1. Move the cursor using arrows keys on field relative to “Memory type”, marked with blue background:

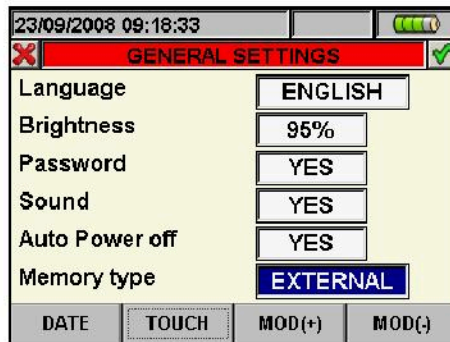



Fig. 16: Memory type setting screen

2. Use **F3** or **F4** keys (alternatively touch **MOD(+)** or **MOD(-)**) to choose “INTERNAL” or “EXTERNAL” memory type.
3. Press **SAVE** or **ENTER** keys (or the smart icon ) to save the selected option and confirm by “Ok”. This selected parameter will be present also after turning off the meter.
4. Press **ESC** key (or the smart icon ) to exit by screen without saving any modify

### 5.1.8. “Touch screen” calibration

This operation is necessary if any internal features of “touch screen” display are not correctly positioned or not more selectable by using the PT400 pointer

1. Select the “TOUCH” item inside the “General settings” section. The message “Do You want to calibrate touch screen?” is shown by the meter. Confirm with “Ok”. The herewith screen is shown:

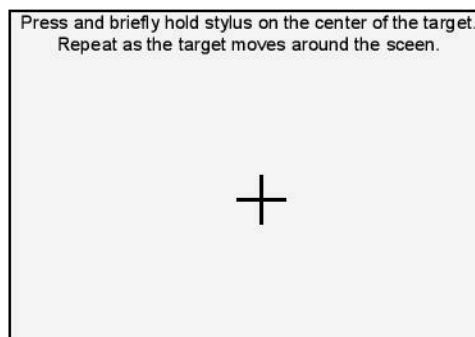

Fig. 17: Touch screen calibration screen

2. By pressing and soft hold the PT400 pointer on the central point of the cross cursor (see Fig. 17) move the cursor to the four corners of display
3. Switch off and than turn on the meter by means of **ON/OFF** key to complete the operation



## 5.2. REAL TIME VALUES

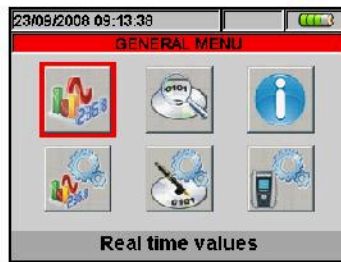

Fig. 18: GENERAL MENU screen - Real time values section

In this section the real time measured values of parameters both on input channels and internally calculated are shown by meter. In particular the following are shown:

1. Values of the electrical and environmental quantities (irradiation, temperature) of a photovoltaic system for generating single-phase or three-phase electric power.
2. Values regarding the maximum efficiency point.
3. AC TRMS voltages, currents and all kind of electrical parameters for any single phase and total, Flicker values and voltages Unbalanced.
4. Voltage and current waveforms for any single phase and total.
5. Voltage and current harmonics up to 49<sup>th</sup> component for any single phase and total both in numerical and histograms graphical format in absolute or percentage value with respect to each fundamental signal.
6. Vectorial diagrams of each voltage and current with the respective phase angles in order to define the correct nature of system loads under test.

The type of data displayed is determined by the setting of the instrument in the Analyzer Configuration mode (see §. 5.3). With reference to PV systems only, further in this manual, the acronym **MPPT** (Multiple Power Point Tracker) shall indicate the characteristic of the DC/AC converter (inverter), capable of maximizing the DC power which can be taken from the photovoltaic field and the acronym **PRp** shall indicate the Performance Ratio evaluated through active powers. See § 10.3 for further details.

### 5.2.1. Single-MPPT photovoltaic system screen – Single-phase output

The instrument displays the following parameters:

	<u>PARAMETERS CAPTION:</u>
	PRp: → Performance Ratio (ref. active powers)
	Pdc → DC power at inverter input
	$\eta_{DC}$ → Photovoltaic panel performance
	Vdc → DC voltage at inverter input
	Idc → DC current at inverter input
	Pac → AC power at inverter output
	Pf → Power factor at inverter output
	$\eta_{AC}$ → Inverter performance
	Vac → AC voltage at inverter output
	Iac → AC current at inverter output
	Tc → Default temperature of photovoltaic panels
	Te → Default environmental temperature
	<b>The display of the Te or Tc values in blue indicates that the mentioned values are the default ones, as the ones measured by SOLAR-0x are not available (see § 5.3.2.4). If the remote unit SOLAR-0x is connected to the main unit, the following values are also available:</b>
	Irr → Solar irradiation
	Pnom → Nominal power of the photovoltaic system
	Tc → Measured temperature of the phot. panels
	Te → Measured environmental temperature

<p>DC →</p> <p>PV →</p>	<p>← AC</p>	<table border="1" style="width: 100%; border-collapse: collapse; font-size: small;"> <tr> <td colspan="2" style="text-align: center;">23/07/2012 15:57:58</td> </tr> <tr> <td colspan="2" style="text-align: center; background-color: yellow;"><b>PHOTOVOLTAIC</b></td> </tr> <tr> <td>PRp = 0.000</td> <td>Pac = 0.00 kW</td> </tr> <tr> <td>Pdc = 0.00 kW</td> <td>pf = 0.00 i</td> </tr> <tr> <td><math>\eta_{DC}</math> = 0.00</td> <td><math>\eta_{AC}</math> = 0.00</td> </tr> <tr> <td>Vdc = 0.0 V</td> <td>Vac = 0.0 V</td> </tr> <tr> <td>Idc = 0.00 A</td> <td>Iac = 0.00 A</td> </tr> <tr> <td>Irr = --- W/m<sup>2</sup></td> <td></td> </tr> <tr> <td>Pnom = 3.000 kW</td> <td></td> </tr> <tr> <td>Tpv = 40.0 °C</td> <td>Tenv = 25.0 °C</td> </tr> <tr> <td colspan="2" style="text-align: center;">RUN</td> </tr> </table>	23/07/2012 15:57:58		<b>PHOTOVOLTAIC</b>		PRp = 0.000	Pac = 0.00 kW	Pdc = 0.00 kW	pf = 0.00 i	$\eta_{DC}$ = 0.00	$\eta_{AC}$ = 0.00	Vdc = 0.0 V	Vac = 0.0 V	Idc = 0.00 A	Iac = 0.00 A	Irr = --- W/m <sup>2</sup>		Pnom = 3.000 kW		Tpv = 40.0 °C	Tenv = 25.0 °C	RUN	
23/07/2012 15:57:58																								
<b>PHOTOVOLTAIC</b>																								
PRp = 0.000	Pac = 0.00 kW																							
Pdc = 0.00 kW	pf = 0.00 i																							
$\eta_{DC}$ = 0.00	$\eta_{AC}$ = 0.00																							
Vdc = 0.0 V	Vac = 0.0 V																							
Idc = 0.00 A	Iac = 0.00 A																							
Irr = --- W/m <sup>2</sup>																								
Pnom = 3.000 kW																								
Tpv = 40.0 °C	Tenv = 25.0 °C																							
RUN																								

Fig. 19: Page of single-phase photovoltaic systems

### 5.2.2. Single-MPPT photovoltaic system screen – Three-phase output

The instrument displays the following parameters:

DC →

PV →

23/07/2012 15:58:18	
PHOTOVOLTAIC	
PRp = 0.000	Pac = 0.00 kW
Pdc = 0.00 kW	pf = 0.00 i
$\eta_{DC}$ = 0.00	$\eta_{AC}$ = 0.00
Vdc = 0.0 V	Vac1 = 0.0 V
Idc = 0.00 A	Iac1 = 0.00 A
Irr = --- W/m <sup>2</sup>	Vac2 = 0.0 V
Pnom = 3.000 kW	Iac2 = 0.00 A
Tpv = 40.0 °C	Vac3 = 0.0 V
Tenv = 25.0 °C	Iac3 = 0.00 A
RUN	

← AC

**PARAMETERS CAPTION:**

PRp: → Performance Ratio (ref. active powers)

Pdc → DC power at inverter input

$\eta_{DC}$  → Photovoltaic panel performance

Vdc → DC voltage at inverter input

Idc → DC current at inverter input

Pac → AC power at inverter output

Pf → Three-phase power factor at inverter output

$\eta_{AC}$  → Three-phase inverter performance

Vac1,2,3 → AC voltage at inverter output

Iac1,2,3 → AC current at inverter output

Tpv → Default temperature of photovoltaic panels

Tenv → Default environmental temperature

**The display of the Tenv or Tpv values in blue indicates that the mentioned values are the default ones, as the ones measured by SOLAR-0x are not available (see § 5.3.2.4).**

If the remote unit SOLAR-0x is connected to the main, the following values are also available:

Irr → Solar irradiation

Pnom → Nominal power of the photovoltaic system

Tpv → Measured temperature of the photovoltaic panels

Tenv → Measured environmental temperature

Fig. 20: Three-phase photovoltaic system page

### 5.2.3. Screen of photovoltaic systems with multi-MPPT inverter (only with MPP300)

For the sake of simplicity, further in this manual, the word “string” will be used, although often the term “photovoltaic field” would be more correct. From the point of view of the instrument, the management of a single string or of more parallel strings (photovoltaic field) is identical.

The instrument SOLAR300N, used together with remote units SOLAR-02 and MPP300 (optional), allows testing PV systems characterized by inverters with 1 or more MPPTs connected to the relevant PV fields (consisting in PV modules with the same direction and inclination) and single-phase or three-phase output.

The remote unit MPP300 communicates with SOLAR300N (to manage data setting, synchronization and download) through the USB connection cable and with the remote unit SOLAR-02 (for recording irradiation and temperature values) via a wireless radiofrequency (RF) connection, which is active up to a maximum distance of 1m between the units.

For further details on the use of MPP300, please see the unit's user manual.



### 5.2.3.1. Multi-MPPT photovoltaic system screen – Single-phase output

When SOLAR300N is in connection with MPP300, the display shows the following parameters:

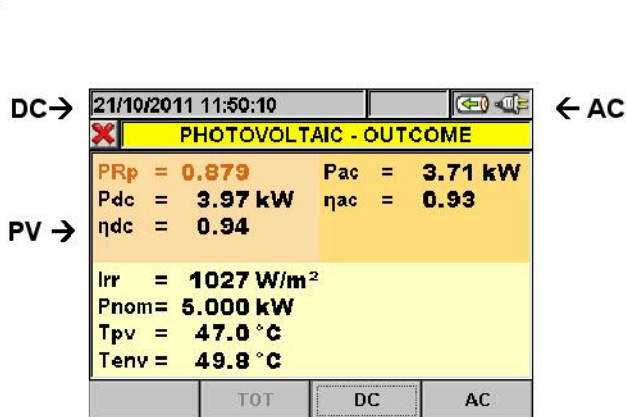

#### PARAMETER CAPTION:

PRp: → Performance Ratio (ref. active powers)

Pdc → Inverter input DC power

η<sub>DC</sub> → Photovoltaic panel performance

Pac → Inverter output AC power

η<sub>AC</sub> → Inverter performance

Pnom → Photovoltaic system rated power

If the remote unit SOLAR-02 is connected to the MPP300, the following values are also available:

Irr → Solar irradiation

Tpv → Default photovoltaic panel temperature

Tenv → Default environmental temperature

**When Tenv or Tpv values are displayed in blue, it means that these values are different from the default ones, as those measured by SOLAR-02 are not available (see § 5.3.2.4)**

Fig. 21: Multi-MPPT photovoltaic system screen – Single-phase output

Pressing the F3 (DC) key displays the following screen:

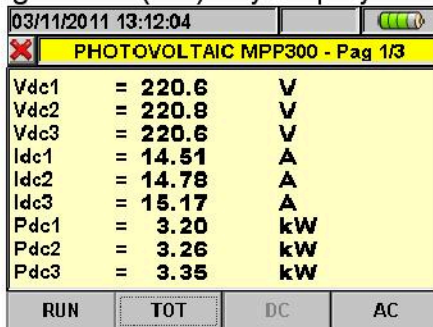

#### PARAMETER CAPTION:

Vdcx → Inverter input DC voltage

Idcx → Inverter input DC current

Pdcx → Inverter input DC power

x=1,2,3 according to the number of MPPTs set

Fig. 22: Multi-MPPT photovoltaic system DC screen – Single-phase output

Pressing the F4 (AC) key displays the following screen:

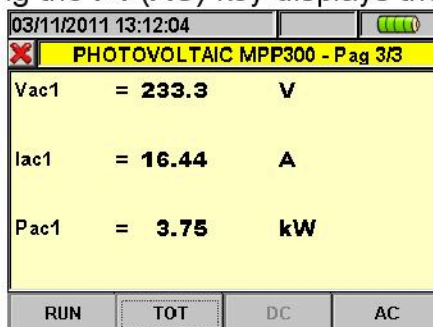

#### PARAMETER CAPTION:

Vac1 → Inverter output phase-neutral AC voltage

Iac1 → Inverter output AC phase current

Pac1 → Inverter output AC power

Fig. 23: Multi-MPPT photovoltaic system AC screen – Single-phase output

### 5.2.3.2. Multi-MPPT photovoltaic system screen – Three-phase output

When SOLAR300N is in connection with MPP300, the display shows the following parameters:

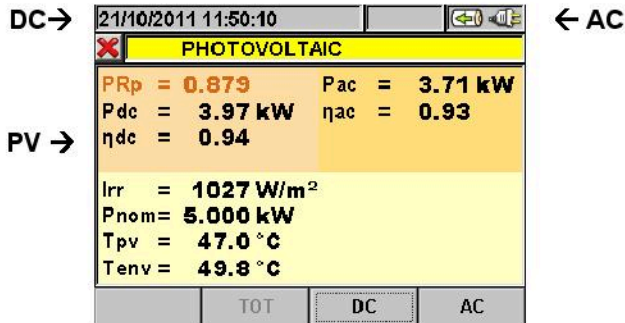

#### PARAMETER CAPTION:

PRp: → Performance Ratio (ref. active powers)

Pdc → Inverter input DC power

η<sub>DC</sub> → Photovoltaic panel performance

Pac → Inverter output AC power

η<sub>AC</sub> → Inverter performance

Pnom → Photovoltaic system rated power

If the remote unit SOLAR-02 is connected to the MPP300, the following values are also available:

Irr → Solar irradiation

Tpv → Default photovoltaic panel temperature

Tenv → Default environmental temperature

**When Tenv or Tpv values are displayed in blue, it means that these values are different from the default ones, as those measured by SOLAR-02 are not available (see §5.3.2.4).**

Fig. 24: Multi-MPPT photovoltaic system screen – Three-phase output

Pressing the F3 (DC) key displays the following screen:

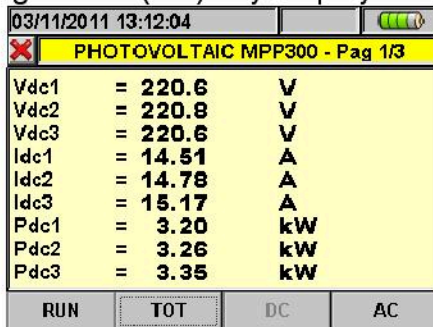

#### PARAMETER CAPTION:

Vdcx → Inverter input DC voltage

Idcx → Inverter input DC current

Pdcx → Inverter input DC power

x=1,2,3 according to the number of MPPTs set

Fig. 25: Multi-MPPT photovoltaic system DC screen – Three-phase output

Pressing the F4 (AC) key displays the following screen:

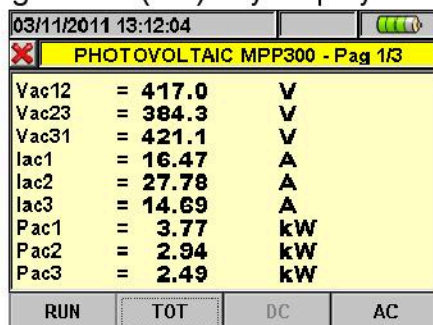

#### PARAMETER CAPTION:

Vacxy → Inverter output phase x-phase y AC voltage

Iacx → Inverter output phase x AC current

Pacx → Inverter output phase x AC power

x=1,2,3 - Phases of the system AC side

Fig. 26: Multi-MPPT photovoltaic system AC screen – Three-phase output

### 5.2.4. Value screens for NPV systems

As an example, below are shown the screens relative to a **three phase 4-wire system**. Similar consideration can be applied to any other selected system. Pressing cyclically F1 key or arrow keys left of right the meter shows the other pages of TRMS measured values which are described in below pictures. Pressing **ESC** key to go back to previous screens or back to GENERAL MENU



## 5.2.4.1. Numerical screens sequence

29/04/2015 09:50:33				
TOTAL RMS VALUES - Page 1/8				
V1N	V2N	V3N	VNPE	V
0.0	0.0	0.0	0.0	
V12	V23	V31		V
0.0	0.0	0.0		
NEG%	ZERO%	SEQ	Hz	
0.0	0.0	000	0.0	
I1	I2	I3	IN	A
0.0	0.0	0.0	0.0	
PAGE	SCOPE	HARM	VECTORS	

## PARAMETERS CAPTION

V1N → Phase-Neutral voltage L1 phase  
 V2N → Phase-Neutral voltage L2 phase  
 V3N → Phase-Neutral voltage L3 phase  
 VNPE → Neutral-Ground voltage  
 V12 → Phase L1 – Phase L2 voltage  
 V23 → Phase L2 – Phase L3 voltage  
 V31 → Phase L3 – Phase L1 voltage  
 NEG% → Unbalance percentage of negative tern  
 ZERO% → Unbalance percentage of zero tern  
 SEQ → phases sequence indication as:  
 "123" = > Corrected  
 "132" = > Reversed  
 "023" = > Null voltage on the Black wire  
 "103" = > Null voltage on the Red wire  
 "120" = > Null voltage on the Brown wire  
 "100" = > Null voltage on the Red and Brown wires  
 "020" = > Null voltage on the Black and Brown wires  
 "003" = > Null voltage on the Black and Red wires  
 Hz → Frequency  
 I1 → Current on L1 phase  
 I2 → Current on L2 phase  
 I3 → Current on L3 phase  
 IN → Current on Neutral

Fig. 27: Page of numerical values

29/04/2015 09:52:16	
TOTAL POWER VALUES - Page 2/8	
Pact	= 0.0 kW
Preact	= 0.0 kVAr
Papp	= 0.0 kVA
Pf	= 0.00 i
CosPhi	= 0.00 i
PAGE	SCOPE HARM VECTORS

## PARAMETERS CAPTION:

Pact → Total Active Power  
 Preact → Total Reactive Power  
 Papp → Total Apparent Power  
 Pf → Total Power Factor  
 CosPhi → Total Power factor considering fundamental  
 → of voltage and current signals

Fig. 28: Page of total power values

29/04/2015 09:52:27	
PHASE 1 RMS VALUES - Page 3/8	
V1N	= 0.0 V
I1	= 0.0 A
Pact1	= 0.0 kW
Preact1	= 0.0 kVAr
Papp1	= 0.0 kVA
Pf1	= 0.00 i
CosPhi1	= 0.00 i
PAGE	SCOPE HARM VECTORS

## PARAMETERS CAPTION:

V1N → Phase-Neutral voltage L1 phase  
 I1 → Current on L1 phase  
 Pact1 → Active Power L1 phase  
 Preact1 → Reactive Power L1 phase  
 Papp1 → Apparent Power L1 phase  
 Pf1 → Power factor L1 phase  
 CosPhi1 → Power factor between fundamental of  
 → voltage L1 and current L1

Fig. 29: Page of Phase 1 values



29/04/2015 09:52:34			
<b>PHASE 2 RMS VALUES - Page 4/8</b>			
V2N	=	<b>0.0 V</b>	
I2	=	<b>0.0 A</b>	
Pact2	=	<b>0.0 kW</b>	
Preact2	=	<b>0.0 kVAR</b>	
Papp2	=	<b>0.0 kVA</b>	
Pf2	=	<b>0.00 i</b>	
CosPhi2	=	<b>0.00 i</b>	
PAGE	SCOPE	HARM	VECTORS

**PARAMETERS CAPTION:**

V2N → Phase-Neutral voltage L2 phase  
 I2 → Current on L2 phase  
 Pact2 → Active Power L2 phase  
 Preact2 → Reactive Power L2 phase  
 Papp2 → Apparent Power L2 phase  
 Pf2 → Power factor L2 phase  
 CosPhi2 → Power factor between fundamental of  
 → voltage L2 and current L2

Fig. 30: Page of Phase 2 values

29/04/2015 09:52:40			
<b>PHASE 3 RMS VALUES - Page 5/8</b>			
V3N	=	<b>0.0 V</b>	
I3	=	<b>0.0 A</b>	
Pact3	=	<b>0.0 kW</b>	
Preact3	=	<b>0.0 kVAR</b>	
Papp3	=	<b>0.0 kVA</b>	
Pf3	=	<b>0.00 i</b>	
CosPhi3	=	<b>0.00 i</b>	
PAGE	SCOPE	HARM	VECTORS

**PARAMETERS CAPTION:**

V3N → Phase-Neutral voltage L3 phase  
 I3 → Current on L3 phase  
 Pact3 → Active Power L3 phase  
 Preact3 → Reactive Power L3 phase  
 Papp3 → Apparent Power L3 phase  
 Pf3 → Power factor L3 phase  
 CosPhi3 → Power factor between fundamental of  
 → voltage L3 and current L3

Fig. 31: Page of Phase 3 values

29/04/2015 09:52:48			
<b>FLICKER - Page 6/8</b>			
	V1N	V2N	V3N
Pst1'	--	--	--
Pst	--	--	--
Pst max	--	--	--
Plt	--	--	--
Plt max	--	--	--
Recording time:	---		
PAGE	SCOPE	HARM	VECTORS

**PARAMETERS CAPTION:**

Pst1' → Short term severity after 1 minute  
 Pst → Short term severity  
 Pstmax → Maximum short term severity  
 Plt → Long term severity  
 Pltmax → Maximum long term severity  
 Recording Time → real time duration of recording  
 expressed in HH:MM

Fig. 32: Page of Flicker values

29/04/2015 09:52:54			
<b>TOT. ENERGY CONSUMPTION - Pag 7/8</b>			
Eact	=	<b>0 kWh</b>	
Ppeak	=	<b>0 kW</b>	
Date Ppeak	:	--/--/--	<b>00:00:00</b>
Start rec.	:	--/--/--	<b>00:00:00</b>
Stop rec.	:	--/--/--	<b>00:00:00</b>
Rec. Time	:	---	
Int. Per.	:	---	Rec. :--
PAGE	SCOPE	HARM	VECTORS

**PARAMETERS CAPTION:**

Eact → Total active energy consumed when starting  
 recording.  
 Ppeak → Maximum peak of consumed active power.  
 Date Ppeak → Date and time in which the peak  
 occurred.  
 Start rec. → Date when recording was started.  
 Stop rec. → Date when recording was stopped.  
 Rec. Time → Time elapsed from Rec Start.  
 Int. Per. → Value of the set integration period.  
 Rec → Number of the recording in progress

Fig. 33: Consumed energy page

### CAUTION



The Total Consumed Energy page is shown only if the instrument has been set for the Recording of the General Parameter Total "Active Power & Energy" (see § 5.4.2.7). Values will be shown only during or at the end of a recording and zeroed upon starting a new recording or when the instrument is switched off

29/04/2015 10:23:15		
<b>TOT. ENERGY PRODUCTION - Pag 8/8</b>		
Eact	=	<b>0 kWh</b>
Ppeak	=	<b>0 kW</b>
Date Ppeak	:	- - / - - / - - <b>00:00:00</b>
Start rec.	:	- - / - - / - - <b>00:00:00</b>
Stop rec.	:	- - / - - / - - <b>00:00:00</b>
Rec. Time	:	- - -
Int. Per.	:	- - - Rec. : - -
PAGE	SCOPE	HARM
VECTORS		

PARAMETERS CAPTION:

Eact → Total active energy produced when starting recording.  
 Ppeak → Maximum peak of produced active power.  
 Date Ppeak → Date and time in which the peak occurred.  
 Start rec. → Date when recording was started.  
 Stop rec. → Date when recording was stopped.  
 Rec Time → Time elapsed from Rec Start.  
 Int. Per. → Value of the set integration period.  
 Rec → Number of the recording in progress

Fig. 34: Produced energy page

### CAUTION



The Total Produced Energy page is shown only if recording parameter "Co-generation" has been set in the instrument (see § 5.4.2.5) and if general parameter Total "Active Power & Energy" has been selected (see § 5.4.2.7). Values will be shown only during or at the end of a recording and zeroed upon starting a new recording or when the instrument is switched off.

29/04/2015 10:24:03		
<b>AVERAGE RMS VALUES - Page 9/9</b>		
AVG V	=	<b>0.0 V</b>
AVG I	=	<b>0.0 A</b>
AVG Pact	=	<b>0.0 kW</b>
AVG Preact	=	<b>0.0 kVAR</b>
PAGE	SCOPE	HARM
VECTORS		

PARAMETERS CAPTION:

AVGV → Average value voltage V1, V2, V3  
 AVGI → Average value current I1, I2, I3  
 AVG Pact → Average value active power on L1, L2, L3  
 AVG Preact → Average value reactive power on  
 → L1, L2, L3

Fig. 35: Page of numerical average values

### CAUTION



The AVERAGE RMS VALUES page will be shown only if option AVERAGE VALUES "YES" is enabled in the Advanced Settings section (see § 5.3.4.5)

### 5.2.5. SCOPE waveforms screens

Starting from a any page of numerical values it's possible to select waveforms screens of the input signals by pressing **F2** key (or touch **SCOPE** at display). By pressing cyclically **F1** key the below screens are shown by meter.

As an example, below are shown the screens relative to a **three phase 4-wire system**. Similar consideration can be applied to any other selected system.

- Simultaneous waveforms of voltages V1, V2, V3 and neutral voltage Vn (for three phase 4-wire system and single phase), with their TRMS values as shown in below screens:

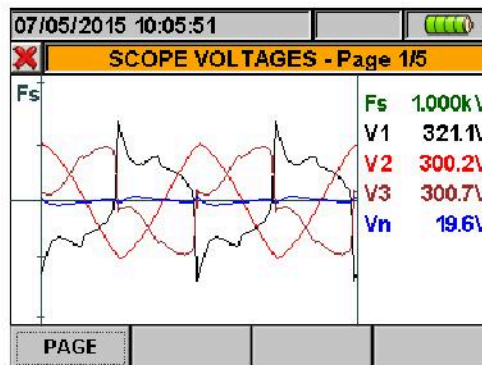

Fig. 36: Voltage waveforms screen for 4-wire systems

- Simultaneous waveforms of currents I1, I2, I3 and neutral current In (for three phase 4-wire system) with their TRMS values as shown in below screens:

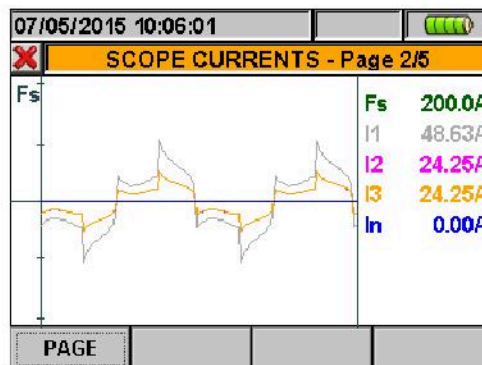

Fig. 37: Current waveforms screen for 4-wire systems

- Waveforms of signals on L1 phase, with their TRMS values, as below shown:

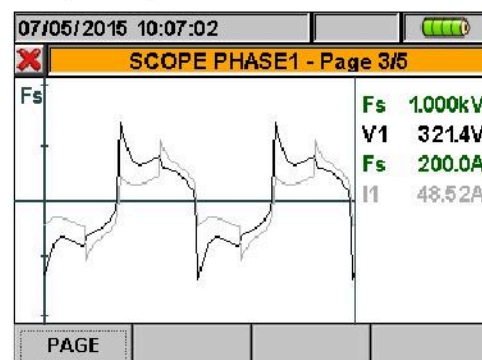

Fig. 38: Voltage/Current waveforms screen L1 phase for 4-wire and 3-wire systems



- Waveforms of signals on L2 phase, with their TRMS values, as below shown:

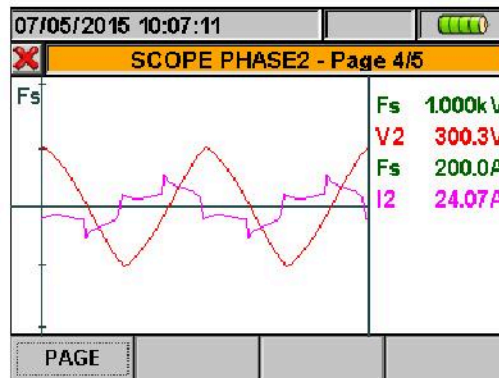

Fig. 39: Voltage/Current waveforms screen L2 phase for 4-wire systems

- Waveforms of signals on L3 phase, with their TRMS values, as below shown:

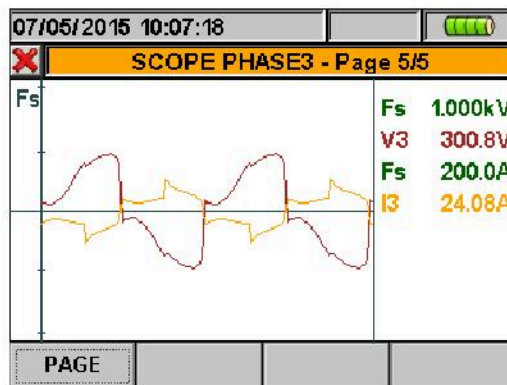



Fig. 40: Voltage/Current waveforms screen L3 phase for 4-wire systems

In Manual mode inside Advanced Settings (see § 5.3.4.1) a customisation of full scale of voltage and current graphic is possible in order to improve the resolution on readings. In this situation pressing arrow keys **ZOOM in** or **ZOOM out** for increase or decrease the value of desired full scale. Press **F2** key to change from current full scale to voltage full scale. Press **ESC** key (or the smart icon ) to quit waveforms screens and go back to TRMS real time values screen.

### 5.2.6. HARM analysis screens

Starting from any page of numerical values it's possible to enter harmonics numerical values and histogram graphics screens section for voltage and current input signals by pressing **F2** key (or touch **HARM** at display). By pressing cyclically **F1** key the below screens are shown by meter.

As an example, below are shown the screens relative to a **three phase 4-wire system**. Similar consideration can be applied to any other selected system.

- Harmonics values of V1, V2, V3 voltages and neutral voltage Vn (for three phase 4-wire system), currents I1, I2, I3 and neutral current In (for three phase 4-wire system) with THD% values both with histogram graphics and with numerical values in percentage or absolute value, (see § 5.3.4.3) as below shown. The **positive** value means the condition of **absorbed** harmonics (mains → loads direction) while the **negative** value means the condition of **generated** harmonics (loads → mains direction)

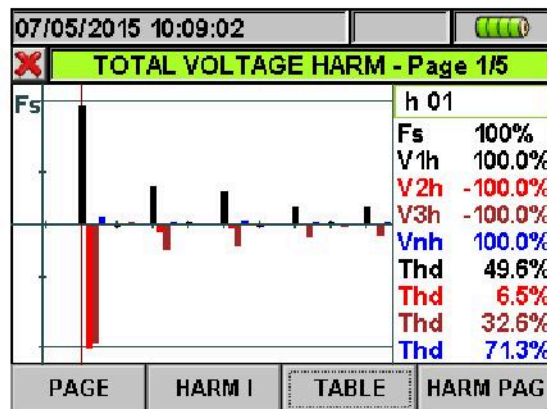

Fig. 41: Harmonic analysis of voltages in percentage value for 4-wire systems

In all case the full scale of graphs is automatically set from meter depending on measured values.

- Change to currents screens by pressing **F2** key (or touch "HARM I" at display). By pressing **F1** key (or the **PAGE** at display) the screens of total values and each phase currents I1, I2, I3 and In (for 4-wire and single phase systems). The main screens are below shown:

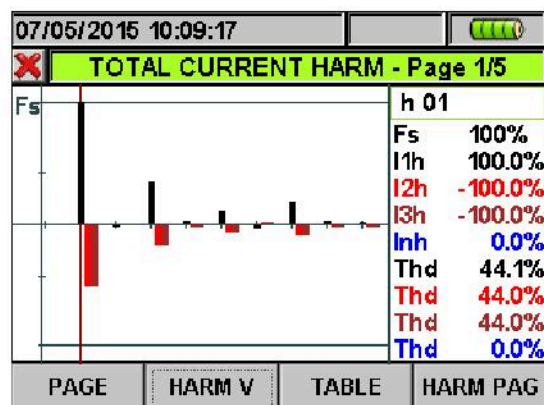

Fig. 42: Harmonic analysis of currents percentage/absolute for 4-wire systems

- Change to screens of numerical values tables of harmonics voltages and currents up to 49<sup>st</sup> both percentage and absolute value (see § 5.3.4) by pressing **F3** key (or touch "TABLE" at display), as shown in below pictures:

07/05/2015 10:09:32				
VOLTAGE HARMONICS				
h%	Phase 1	Phase 2	Phase 3	Neutral
Thd%	49.9	6.6	32.8	70.9
Dc	0.0	0.0	0.0	0.0
h1	100.0	-100.0	-100.0	100.0
h2	-1.2	0.5	0.9	0.9
h3	30.9	-6.1	-21.0	36.4
h4	0.9	0.1	-0.6	1.3

HARM I   GRAPHIC   HARM PAG

Fig. 43: Harmonic analysis voltages in percentage value for 4-wire systems

07/05/2015 10:09:40				
CURRENT HARMONICS				
h%	Phase 1	Phase 2	Phase 3	Neutral
Thd%	43.9	43.8	43.8	0.0
Dc	0.0	0.0	0.0	0.0
h1	100.0	-100.0	-100.0	0.0
h2	-1.5	1.4	1.4	0.0
h3	33.9	-33.8	-33.8	0.0
h4	2.9	-2.9	-2.9	0.0

HARM V   GRAPHIC   HARM PAG

Fig. 44: Harmonic analysis currents in percentage value for 4-wire systems

Press **F3** key to back to graphical screens and **F2** key to change voltages' or currents' screens. Press **F4** key or the up and down arrows (or touch the "HARM PAG" at display) to show the screens relative to other harmonics orders up to 49<sup>st</sup>.

- Harmonics values of single V1, V2, V3 voltages and neutral voltage Vn and single currents I1, I2, I3 and neutral current In (for three phase 4-wire system) with THD% values both with histogram graphics and with numerical values in percentage or absolute value depending on the desired settings. These values are shown in four pages selectable by pressing cyclically the **F1** key (or touch the "PAGE" at display). On Fig. 45 and Fig. 46 are display as an example, the situation relative to L1 phase for voltage and current on 4-wire systems is shown in the next pictures:

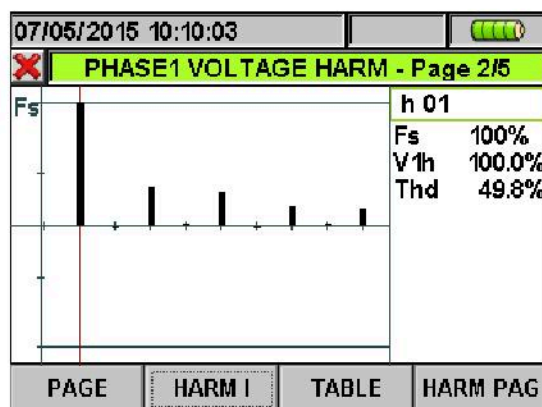

Fig. 45: Harmonic analysis voltage V1 in percentage values for 4-wire system



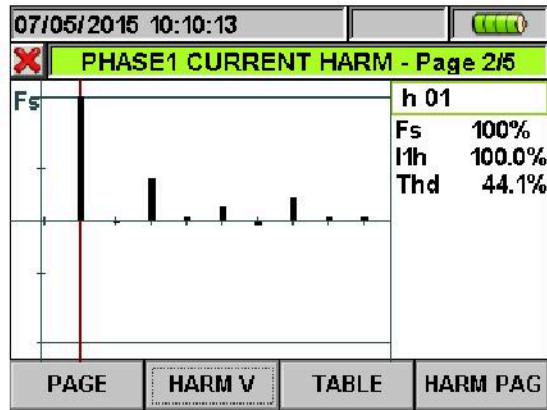

Fig. 46: Harmonic analysis of current I1 in percentage/absolute values for 4-wire system

### 5.2.7. Vectorial diagrams screens

Starting from a any page of numerical values it's possible to select the vectorial diagrams screens of voltage and currents by pressing **F4** key (or touch "VECTORS" at display). The aim of this feature is to show, with numerical and graphical indications, the phase angles, expressed in degree [°] between the three voltages V1, V2 and V3 and the currents I1, I2 and I3 in order to understand in each moment the inductive or capacitive loads nature of electrical installations. As an example, below are shown the screens relative to a **three phase 4-wire system**. Similar consideration can be applied to any other selected system. By pressing cyclically **F1** key the below screens are shown by meter:

- Vectorial diagram total of phase angles among V1, V2, V3 and between V1-I1, V2-I2, V3-I3 more than indication of percentage values of "NEG%" e "ZERO%" parameters (see § 10.8):

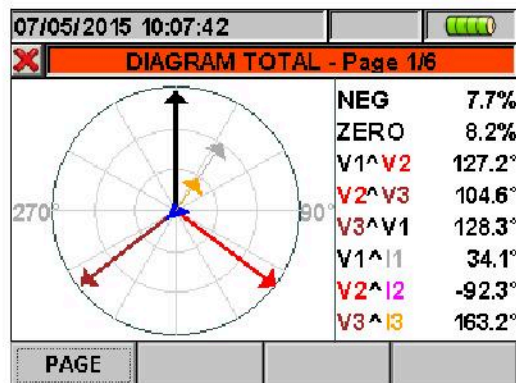

Fig. 47: Vectorial diagram total for 4-wire system

- The vectorial diagram of single voltages depending on the type of selected systems as shown in below screens:

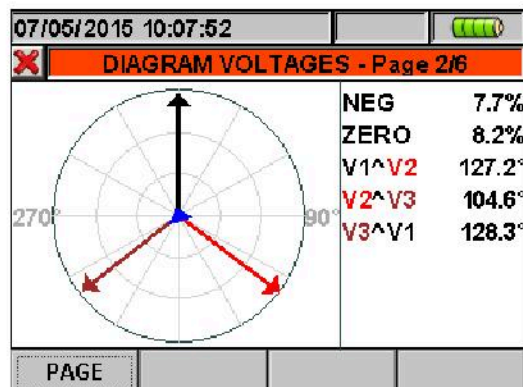

Fig. 48: Vectorial voltage diagram for 4-wire system



- The vectorial diagram of voltage and current for each phase depending on the type of system as shown in below screens:

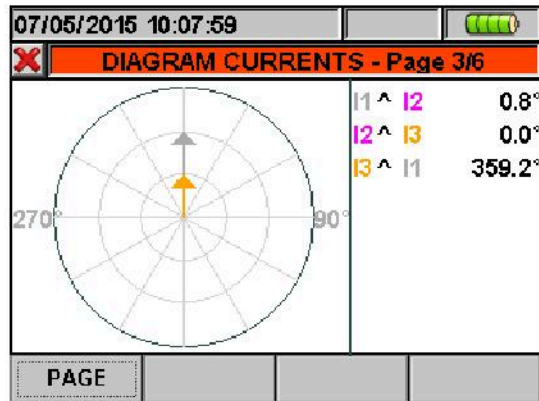

Fig. 49: Vectorial current diagram for 4-wire system

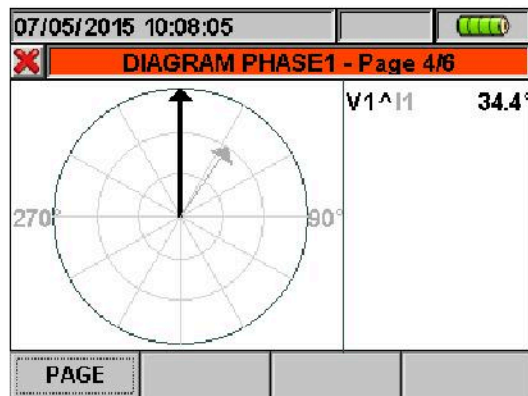

Fig. 50: Vectorial voltage/current diagram L1 phase for 4-wire system

Pressing **ESC** key (or smart icon  at display) to exit from each screen and back to the previous one.



### CAUTION

- The vectors of voltages are referred to the external circle on each diagram and the vectors of current are referred to second circle. The vectors' sizes are designed so that the vector of maximum amplitude can touch the circle and the other vectors are scaled with respect to it proportionally to their amplitude.
- The rotation positive reference associated at each vectorial diagram is **clockwise**.

### 5.3. ANALYZER SETTINGS

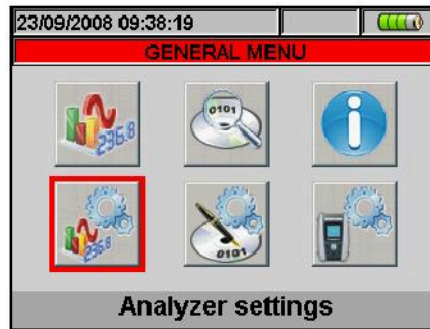

Fig. 51: Analyzer settings screen

In this section, the instrument allows carrying out basic and advanced selections according to the type of installation being tested. In particular, it is possible to:

#### For single-phase and three-phase photovoltaic systems (PV):

- Select the type of system, the frequency and the full scale of the clamps used (Photovoltaic configuration)
- Set the characteristic parameters of the photovoltaic system being tested such as the nominal power of the system, the  $\gamma$  (**Gamma**) and **NOCT** coefficients of the panels used for system construction, the default values for the temperature of the panels and the environmental temperature at which the panels are, the type of mathematical relationship to correct the power which can be generated by the panels when the temperature varies (Parameter Setting) and the number of MPPTs in the concerned inverter (only together with opt. MPP300 units).
- Set the type of remote unit, the **coefficient of the pyranometer (sensitivity)**, the **minimum threshold of irradiance** which is considered by meter and the **correction k factor of DC clamp** (Advanced Settings).

#### For single-phase and three-phase non-photovoltaic electrical systems (NPV):

- Select the type of system, the frequency, the kind of current clamp, the full scale of current clamp and the VT ratio of external voltage transformer which can be connected with meter (Analyser Configuration)
- Setting the Manual mode for the customisation of full scale on graphic screen of Real Time section, the type of harmonic to be shown on screens, the percentage or absolute values of harmonics, the harmonics zoom, the average calculation of voltages, currents, active and reactive powers (Advanced Settings)

We suggest the use of smart icons  and  in order to perform a complete interaction with the meter.

#### 5.3.1. Analyzer Configuration screen

Inside the "Analyzer configuration" section a screen depending on the type of system selected by user during the last operation is shown by meter: The instrument is granted for a correct measurement only in connection with the following electrical systems:

- Single-phase photovoltaic system **PV-1**
- Three-phase photovoltaic system **PV-3**
- Single-/Multi-MPPT PV system – single-phase output (via opt. MPP300) **MPP-1**
- Single-/Single-MPPT PV system – three-phase output (via opt. MPP300) **MPP-3**
- Three phase system **4WIRE** (Three phase four wire WYE system + ground)
- Three phase system **3WIRE** (Three phase system three wire WYE (no Neutral) + ground)

- Three phase system **ARON** (Three phase system three wire DELTA ARON - 2 wattmeter method + ground)
- SINGLE phase system (phase + neutral+ ground)
- Three phase system 4-wire “**3PHL** (Three phase four wire DELTA system with center tapped high leg + ground – USA systems)
- Two phase system 3-wire “**3POY** (Open WYE three wire system with 2 transformer windings + ground)” – USA systems
- Three phase system 3-wire “**3POD** (Open DELTA three wire system with 2 transformer windings + ground)” – USA systems
- Two phase system 3-wire “**3P2E** (Three phase three wire system without Voltage/current sensor on phase L3 + ground )” – USA systems
- Two phase system 3-wire “**1Ph3W** (Split phase + ground) – USA systems

The screen displayed by the instrument for each of the above-listed situations are reported below:

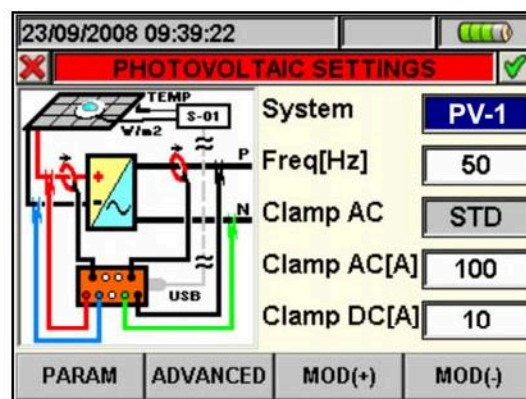

Fig. 52: Screen for analyzer configuration for PV-1 system

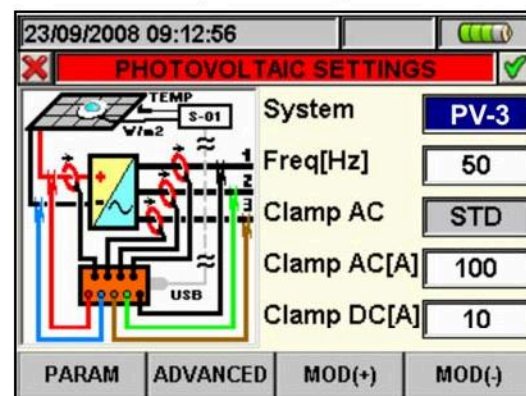

Fig. 53: Screen for analyzer configuration for PV-3 system

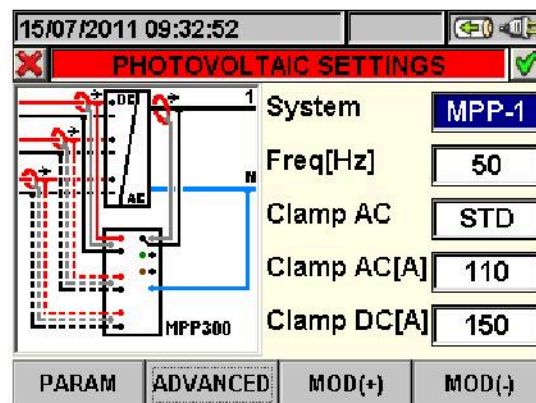

Fig. 54: Analyzer configuration for MPP-1 system (opt. MPP300 required)



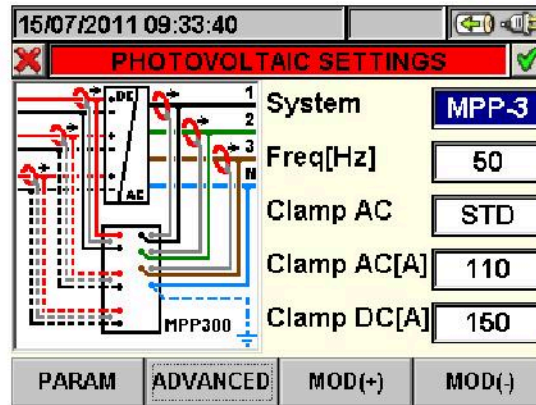

Fig. 55: Analyzer configuration for MPP-3 system (opt. MPP300 required)

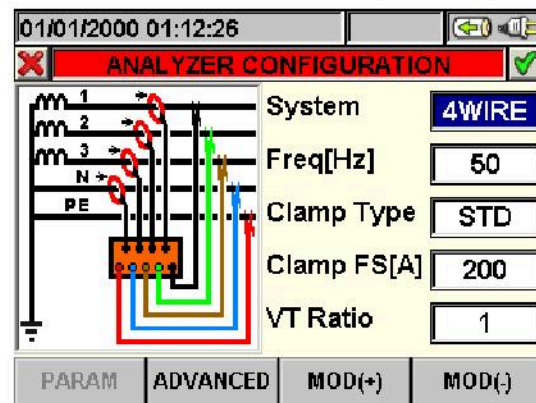

Fig. 56: Analyzer configuration screen for 4-wire system

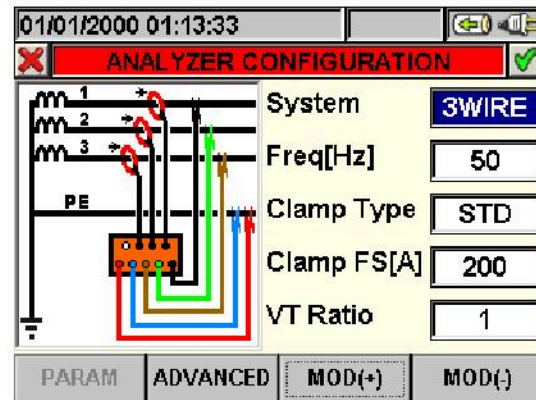

Fig. 57: Analyzer Configuration screen for 3-wire system

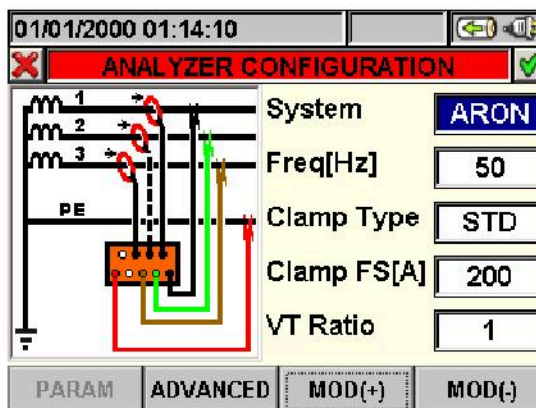

Fig. 58: Analyzer Configuration screen for ARON system

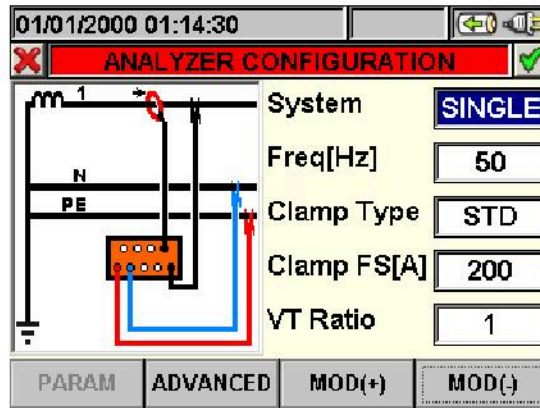

Fig. 59: Analyzer Configuration screen for SINGLE phase system

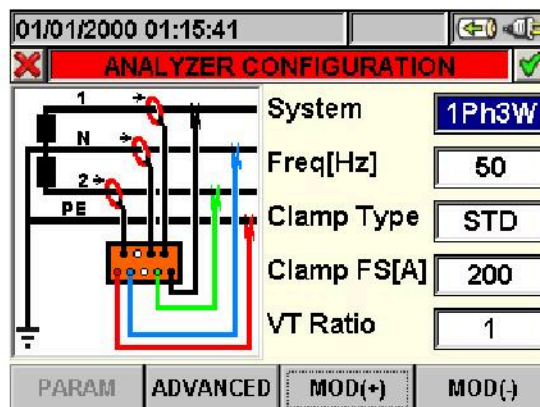

Fig. 60: Analyzer Configuration screen for Two phase system 3-wire 1Ph3W

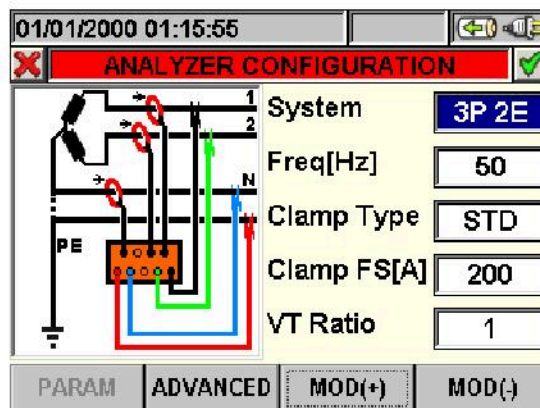

Fig. 61: Analyzer Configuration screen for Two phase system 3-wire 3P 2E

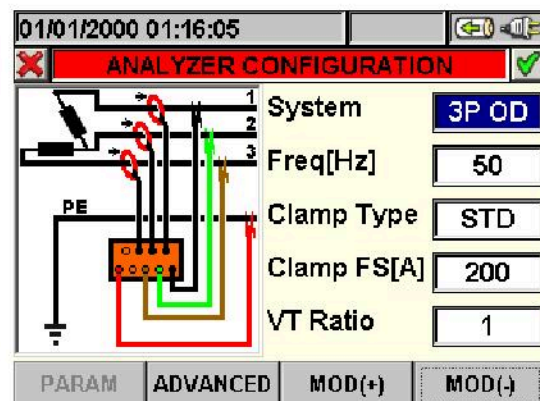

Fig. 62: Analyzer Configuration screen for Three phase system 3-wire 3P OD

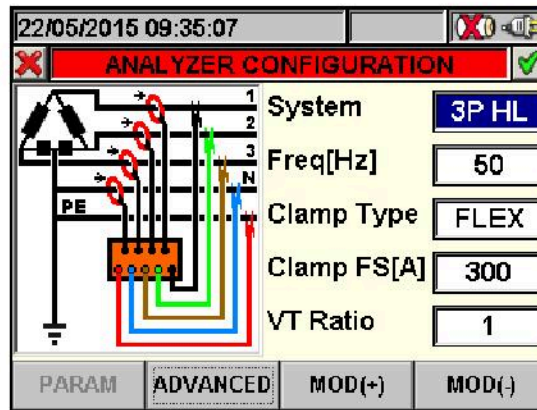

Fig. 63: Analyzer Configuration screen for Three phase system 4-wire 3P HL

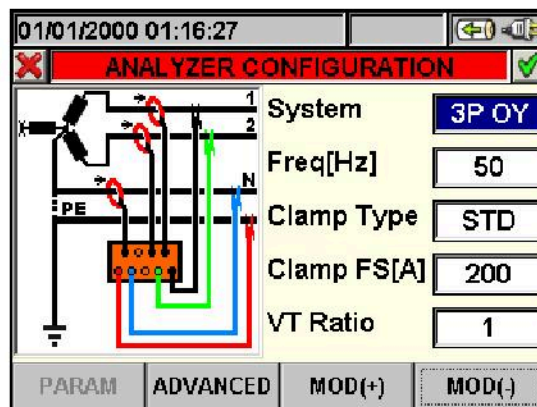





Fig. 64: Analyzer Configuration screen for Two phase system 3-wire 3P OY

1. Move the cursor using arrows keys on field relative to **"System"**, marked with blue background.
2. Use **F3** or **F4** keys (alternatively touch **MOD(+)** o **MOD(-)**) to select the type of system choosing among "4-WIRE", "3-WIRE", "ARON" or "SINGLE" options.
3. Press **SAVE** or **ENTER** keys (or the smart icon ) to save the selected option and confirm by "Ok". This selected parameter will be present also after turning off the meter.
4. Press **ESC** key (or the smart icon ) to quit without saving any modification.

#### 5.3.1.1. Setting system frequency

1. Move the cursor using arrows keys on field relative to **"Freq[Hz]"**, marked with blue background.
2. Use **F3** or **F4** keys (alternatively touch **MOD(+)** o **MOD(-)**) to select the system frequency choosing between **50Hz** or **60Hz** options. This parameter is relevant **ONLY** if the input voltage not permits to recognize the frequency value (for example, only the clamps for the current measurement are connected). In this case the instrument generates an internal synchronism equal to the value of the set frequency.
3. Press **SAVE** or **ENTER** keys (or the smart icon ) to save the selected option and confirm by "Ok". This selected parameter will be present also after turn off the meter.
4. Press **ESC** key (or the smart icon ) to quit without saving any modification



### 5.3.1.2. Setting clamp type

This parameter **must be always set equal to the clamp type used**.



Two types of clamps are available:

- ✓ STD: for Standard clamps or external Current Transformer CT
- ✓ FLEX: for Flexible clamps (Rogowski)



#### CAUTION

If the **PV-1** or **PV-3** systems are set on meter the “**STD**” clamp type is the only possibility (not modified) both for DC and AC clamps. **The FLEX type clamp NOT BE ok for PV systems**

1. Move the cursor using arrows keys on field relative to “**Clamp Type**”, marked with blue background.
2. Use **F3** or **F4** keys (alternatively touch **MOD(+)** o **MOD(-)**) to select clamp type choosing between **STD** or **FLEX** options.
3. Press **SAVE** or **ENTER** keys (or the smart icon ) to save the selected option and confirm by “Ok”. This selected parameter will be present also after turn off the meter.
4. Pressing **ESC** key (or the smart icon ) to quit without saving any modification

### 5.3.1.3. Setting full scale of clamps



#### CAUTION



- The value of this parameter **must be always equal to the full scale of the current clamps** used to take the measurement. In case multi-scale clamps are used, the value of this parameter must be equal to the scale selected on the clamps
- If the type of system set is **PV-1** or **PV-3**, **MPP-1**, **MPP-3** it will be necessary to set the full scale both for the DC clamps and for the AC clamps

1. By means of the up and down arrow keys, move the cursor on item “**AC[A] clamps**” and “**DC[A] clamps**” for PV systems or on “**FS Clamps[A]**” for NPV systems, so that it is highlighted in blue.
2. Use **F3** or **F4** keys (alternatively touch **MOD(+)** o **MOD(-)**) to select the desired full scale





#### CAUTION

- In case of STD clamps any value can be set by using **F3** or **F4** keys (alternatively touch **MOD(+)** o **MOD(-)**). In case of FLEX clamp only **300A** or **3000A** options are possible. In case of **MPP-1** or **MPP-3** system, for FLEX clamps only the following values shall be available: **100A** and **1000A**.
- In case of STD clamp measured values of current **< 0.1% FS** are zeroed
- In case FLEX clamps with a capacity of 100A or 300A are used, current values **< 1A** are zeroed
- In case FLEX clamps with a capacity of 1000A or 3000A are used, current values **< 5A** are zeroed

3. Press **SAVE** or **ENTER** keys (or the smart icon ) to save the selected option and confirm by “Ok”. This selected parameter will be present also after turning off the meter.
4. Pressing **ESC** key (or the smart icon ) to quit without saving any modification

#### 5.3.1.4. Setting VT ratio

For **NPV systems** the meter can be interfaced also with step-down transformers in the equipment under test. It can display the value of the voltages present on the primary winding of these transformers. To do this it will be necessary to set the value of the transformers' windings ratio

1. Move the cursor using arrows keys on field relative to "**VT Ratio**", marked it with blue background.
2. Use **F3** or **F4** keys (alternatively touch **MOD(+)** or **MOD(-)**) for selection of desired value from **1** to **3000**. Leave the default value "**1**" if no voltage transformer is present on installation.
3. Press **SAVE** or **ENTER** keys (or the smart icon ) to save the selected option and confirm by "Ok". This selected parameter will be present also after turning off the meter.
4. Press **ESC** key (or the smart icon ) to quit without saving any modification.

### 5.3.2. Parameter setting screen – PV systems

Press the **F1** key or touch the “PARAM” item on the display. The instrument displays the following screen:

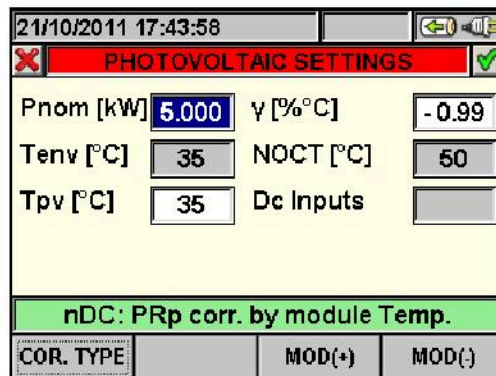



Fig. 65: Parameter setting screen for PV systems

In this screen it is possible to set the characteristic parameters of the photovoltaic system being tested such as the nominal power of the system, the  $\gamma$  and NOCT coefficients of the panels used for system construction, the default values for the temperature of the panels and the environmental temperature at which the panels are, the type of mathematical relationship to correct the power which can be generated by the panels when the temperature varies (the relationship now in use is displayed on the message bar).



#### 5.3.2.1. Setting the nominal power of the photovoltaic system

This option allows setting the maximum nominal value of the power of the photovoltaic system (PV)

1. Move the cursor on “**Pnom**” by means of the up or down arrow keys, so that it is highlighted in blue
2. By means of the **F3** or **F4** key (or items **MOD(+)** or **MOD(-)** on the display), select the desired value
3. Press the **SAVE** or **ENTER** key (or the smart icon ) to save the selected setting by confirming with “Ok”. In this way, the settings made will remain valid also after turning off the instrument
4. To quit the settings made or to exit without saving, press the **ESC** key (or the smart icon )

#### 5.3.2.2. Setting the Gamma parameter of photovoltaic panels



This option allows setting the value of the Gamma parameter ( $\gamma$ ), **coefficient of variation of Power according to Temperature**, one of the characteristic parameters of the panels used for the realization of a PV system, **expressed in % °C and typically negative**

1. Move the cursor on “**γ**” by means of the up or down arrow keys, so that it is highlighted in blue.
2. By means of the **F3** or **F4** key (or items **MOD(+)** or **MOD(-)** on the display), select the desired value within the range  $-0.01 \div -1.00$ .
3. Press the **SAVE** or **ENTER** key (or the smart icon ) to save the selected setting by confirming with “Ok”. In this way, the settings made will remain valid also after turning off the instrument
4. To quit the settings made or to exit without saving, press the **ESC** key (or the smart icon )



### 5.3.2.3. Setting the NOCT parameter of photovoltaic panels

This option allows setting the value of the **NOCT coefficient (nominal working temperature of a PV cell)**, one of the characteristic parameters of the panels used for the realization of a PV system, **expressed in °C**

1. Move the cursor on “**NOCT**” by means of the up or down arrow keys, so that it is highlighted in blue.
2. By means of the **F3** or **F4** key (or items **MOD(+)** or **MOD(-)** on the display), select the desired value within the range **0 ÷ 100°C**
3. Press the **SAVE** or **ENTER** key (or the smart icon ) to save the selected setting by confirming with “Ok”. In this way, the settings made will remain valid also after turning off the instrument.
4. To quit the settings made or to exit without saving, press the **ESC** key (or the smart icon )



### 5.3.2.4. Setting temperatures Tenv and Tpv

This option allows setting the default value of environmental temperature (Tenv) and cell temperature (Tpv)



#### CAUTION

The values of Tenv and Tpv set inside this section are used by meter if are not measured by SOLAR-0x unit as the supplied temperature probe has not been connected. In this condition **the values are marked in blue colour** on the real time value section

1. Move the cursor on “**Tenv**” or “**Tpv**” by means of the up or down arrow keys, so that it is highlighted in blue
2. By means of the **F3** or **F4** key (or items **MOD(+)** or **MOD(-)** on the display), select the desired value within **0 ÷ 80°C** for Tenv and within **0 ÷ 100°C** for Tpv
3. Press the **SAVE** or **ENTER** key (or the smart icon ) to save the selected setting by confirming with “Ok”. In this way, the settings made will remain valid also after turning off the instrument
4. To quit the settings made or to exit without saving, press the **ESC** key (or the smart icon )



### 5.3.2.5. DC input N setting (only together with opt. MPP300)

This option allows setting the number of MPPTs of the inverter of the PV system being tested.



#### CAUTION

It will be possible to set the above-mentioned parameter only if, under “Analyzer Settings” → a system of the “**MPP-1**” or “**MPP-3**” type has been selected.

1. Position the cursor onto item “**DC inputs**” using the up and down arrow keys in order to highlight it in blue.
2. Using the **F3** or **F4** keys (or the items **MOD(+)** or **MOD(-)** on the display), select the desired value.
3. Press the **SAVE** or **ENTER** keys (or the smart icon ) to save the selected setting and confirm with “Ok”. In this case, the settings chosen shall remain valid also after switching off the instrument.
4. To quit the modifications made or to exit without saving, press the **ESC** key (or the smart icon )

### 5.3.2.6. Selection of the relationship for Temperature effects compensations

This option allows selecting the relationship to be used to correct the measurements performed according to the modules' temperature. The following correction modes are available:

- T.mod.: Correction factor Rfv2 related to PV module Temp. (Italian guideline CEI-82-25)
- T.env: Correction factor Rfv2 related to environment Temp. (Italian guideline CEI-82-25)
- ndc: PRp (Performance ratio for active power) corrected by PV module Temp.



#### CAUTION

When performing test according to Italian guideline it is recommended to select "T.env."

Corr. Type	Temperature (Tcel)	PRp calculation	Ref.
T.mod.	Tcel = Tmodule_Meas	$Rfv2 = \begin{cases} 1 & \text{(if } T_{cel} \leq 40^{\circ}\text{C)} \\ 1 - (T_{cel} - 40) \times \frac{ \gamma }{100} & \text{(if } T_{cel} > 40^{\circ}\text{C)} \end{cases}$ $\rightarrow PRp = \frac{P_{ca}}{\left[ Rfv2 \times \frac{G_p}{G_{STC}} \times P_n \right]}$	CEI 82-25
T.amb.	$T_{cel} = \left( T_{amb} + (NOCT - 20) \times \frac{I_{rr}}{800} \right)$		
$\eta_{dc}$	Tcel = Tmodule_Meas	$PRp = \frac{G_{STC}}{G_p} \times \left[ 1 + \frac{ \gamma }{100} \times (T_{cel} - 25) \right] \times \frac{P_{ca}}{P_n}$	...

where:

Symbol	Description	Meas. unit
$G_p$	Irradiance on PV module surface	[W/m <sup>2</sup> ]
$G_{STC}$	Standard Irradiance = 1000	[W/m <sup>2</sup> ]
$P_n$	Nominal Power = sum of all power module (Pmax ) included in the part of PV plant under test	[kW]
$P_{ca}$	AC Active Power measured	[kW]
Rfv2	Thermal Coefficient factor	
$ \gamma $	Absolute value of Pmax thermal coefficient	[%/°C]
NOCT	Normal Operating Cell Temperature (@ 800W/m <sup>2</sup> , 20°C, AM=1.5, Air speed = 1m/s).	[%/°C]

For further details see § 10.1



### 5.3.3. Advanced setting screen – PV systems

Press the **F2** key or touch the “**ADVANCED**” item on the display. The instrument displays the following screen:

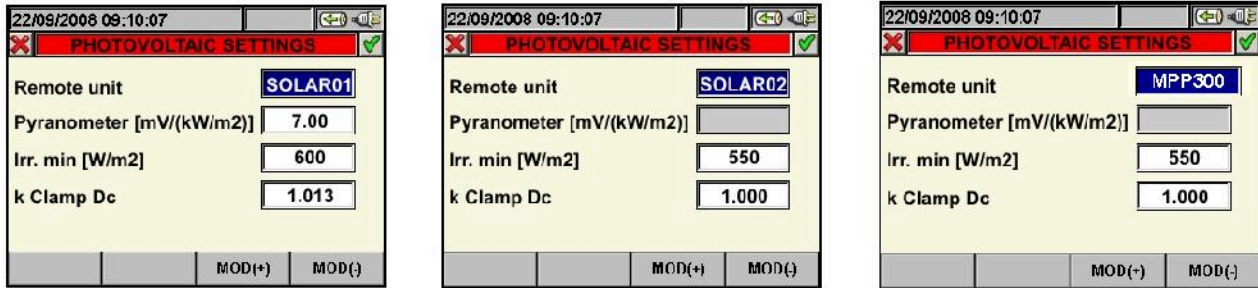

Selection of rem. U. SOLAR-01

Selection of rem. U. SOLAR-02

Selection of rem. U. MPP300

Fig. 66: Advanced setting screen for PV systems

#### 5.3.3.1. Setting of remote unit

This option allows to set the type of remote unit which can be used with the instrument.

1. By means of the **F3** or **F4** key (or items **MOD(+)** or **MOD(-)** on the display), select the desired unit **SOLAR01** or **SOLAR02**, **MPP300**

#### CAUTION



The selection of remote unit **SOLAR-02** or **MPP300** automatically disables the “Pyranometer” field as the sensitivity of the used irradiance probe (pyranometer or reference cell) should be set inside the internal menu of SOLAR-02 (see user manual of SOLAR-02).  
The selection of the type of system MPP-1 or MPP-3 (see §5.3.1) shall automatically force MPP300 as remote unit type.

2. Press the **SAVE** or **ENTER** key (or the smart icon ) to save the selected setting by confirming with “Ok”. In this way, the settings made will remain valid also after turning off the instrument.
3. To quit the settings made or to exit without saving, press the **ESC** key (or the smart icon )

#### 5.3.3.2. Setting the corrective factor of the pyranometer (only for SOLAR-01 unit)

This option allows setting the characteristic corrective factor (sensitivity) of the supplied pyranometer

#### CAUTION





- The sensitivity parameter is normally indicated on the label of pyranometer or on the relevant certificate is normally expressed in  $\mu\text{V}/\text{Wm}^{-2}$  so, considered the measurement unit on meter [ $\text{mV}/\text{kWm}^{-2}$ ] **simply set the value read on label without any unit conversion**
- A wrong setting of sensitivity parameter on meter means a significative error on the irradiance measurement and, then, a wrong DC efficiency calculation

1. By means of the **F3** or **F4** key (or items **MOD(+)** or **MOD(-)** on the display), select the desired value within the range **1.00 ÷ 100.00**
2. Press the **SAVE** or **ENTER** key (or the smart icon ) to save the selected setting by confirming with “Ok”. In this way, the settings made will remain valid also after turning off the instrument.
3. To quit the settings made or to exit without saving, press the **ESC** key (or the smart icon )



### 5.3.3.3. Setting of minimum irradiance threshold

This option allow to set the minimum irradiance threshold used by meter as reference during measurement.

1. By means of the **F3** or **F4** key (or items **MOD(+)** or **MOD(-)** on the display), select the desired value within the range **400 ÷ 800 W/m<sup>2</sup>**
2. Press the **SAVE** or **ENTER** key (or the smart icon ) to save the selected setting by confirming with "Ok". In this way, the settings made will remain valid also after turning off the instrument
3. To quit the settings made or to exit without saving, press the **ESC** key (or the smart icon )

### 5.3.3.4. Setting of corrective constant of DC clamp

This option allow to set the corrective K factor relative only to the supplied HT4004 DC clamp **which is indicated on the label in the backside of clamp** (see Fig. 67)

In case no label is present, set k = 1.000

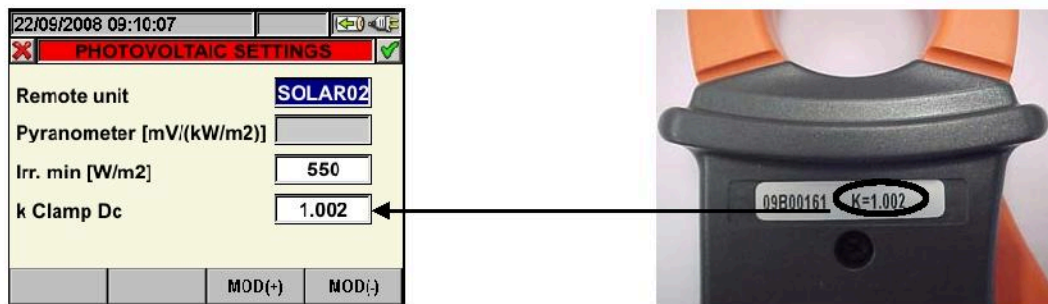



Fig. 67: Set of corrective constant for DC clamp



### CAUTION

For HT4004 DC clamp which do not have the label with the corrective constant K and for other type of DC clamps do not modify the **1.000** factory value

1. By means of the **F3** or **F4** key (or items **MOD(+)** or **MOD(-)** on the display), select the desired value within the range **0.950 ÷ 1.050**
2. Press the **SAVE** or **ENTER** key (or the smart icon ) to save the selected setting by confirming with "Ok". In this way, the settings made will remain valid also after turning off the instrument
3. To quit the settings made or to exit without saving, press the **ESC** key (or the smart icon )

### 5.3.4. Advanced Settings screen – NPV systems

By pressing **F2** key (or touch the “**ADVANCED**” at display) in any screen of “Analyzer Configuration” section, below screen is shown by meter:

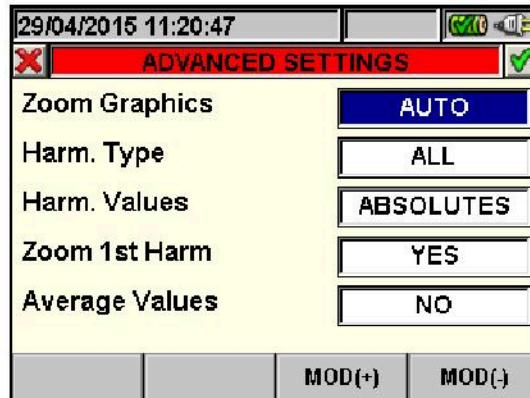



Fig. 68: Advanced Settings screen

In the above screen is possible to select advanced options which have effect in Real Time values screens of meter.



#### 5.3.4.1. Zoom graphics option

This option permits to select a customized full scale **on each phase** of voltage and current waveforms (see Fig. 38, Fig. 39, Fig. 40) in order to better the resolution of readings.

1. Move the cursor using arrows keys on field relative to “**Zoom graphics**”, marked with blue background.
2. Use **F3** or **F4** keys (alternatively touch **MOD(+)** o **MOD(-)**) to select one of below options:
  - ✓ **MANUAL**: define a customized full scale for waveforms’ visualization choosing among the available values. A value included from **2.0A** to **5000kA** it’s set for current and included from **2.0V** to **2000kV** it’s set for voltage.
  - ✓ **AUTO**: the full scale values are automatically modified by the meter
3. Press **SAVE** or **ENTER** keys (or the smart icon ) to save the selected option and confirm by “Ok”. This selected parameter will be present also the turn off of meter.
4. Press **ESC** key (or the smart icon ) to quit without saving any modification.

### 5.3.4.2. Harmonics type option

This option permits to select the type of harmonics which can be shown inside Real Time values section

1. Move the cursor using arrows keys on field relative to "**Harm. type**", marked it with blue background.
2. Use **F3** or **F4** keys (alternatively touch **MOD(+)** o **MOD(-)**) to select one of below options:
  - ✓ **ALL**: the meter shows all the harmonics up to the 49<sup>st</sup>
  - ✓ **EVEN**: the meter shows all the even harmonics up to the 49<sup>st</sup>
  - ✓ **ODD**: the meter shows all the odd harmonics up to the 49<sup>st</sup>
3. Press **SAVE** or **ENTER** keys (or the smart icon ) to save the selected option and confirm by "Ok". This selected parameter will be present also the turn off of meter.
4. Press **ESC** key (or the smart icon ) to quit without saving any modification.





#### CAUTION

Not depending on selected harmonics type for the visualization, the meter can performs the recording of all values in any case.

### 5.3.4.3. Harmonics values option

This option permits to select the value of harmonics which can be shown inside Real Time values' section

1. Move the cursor using arrows keys on field relative to "**Harm. values**", marked it with blue background.
2. Use **F3** or **F4** keys (alternatively touch **MOD(+)** o **MOD(-)**) to select one of below options:
  - ✓ **ABSOLUTE**: the meter shows the harmonics in absolute values (in V unit for voltages and A unit for currents).
  - ✓ **PERCENTAGE**: the meter shows the harmonics in percentage value respect each fundamental.
3. Press **SAVE** or **ENTER** keys (or the smart icon ) to save the selected option and confirm by "Ok". This selected parameter will be present also the turn off of meter.
4. Press **ESC** key (or the smart icon ) to quit without saving any modification.





#### CAUTION

Independently of the harmonics value selected for display, the meter can perform the recording of **absolute** values anyway.



#### 5.3.4.4. Zoom with respect to the 1st harmonic option



This option permits to show harmonics graphics with a zoom relative to the first harmonic order (fundamental) or with a zoom relative to the highest amplitude harmonic inside the Real Time values section. Also in this case the aim is to better the final resolution of graphics

1. Move the cursor using arrows keys on field relative to "**Zoom 1st harm**" , marked it with blue background.
2. Use **F3** or **F4** keys (alternatively touch **MOD(+)** o **MOD(-)**) to select one of below options:
  - ✓ **YES**: the meter performs the graphics zoom respect to the first harmonic
  - ✓ **NO**: the meter performs the graphics zoom respect to the highest amplitude harmonics except for the first harmonic. This option is active only if the zoom graphic option (see 5.3.4.1) is set on AUTO mode
3. Press **SAVE** or **ENTER** keys (or the smart icon ) to save the selected option and confirm by "Ok". This selected parameter will be present also the turn off of meter.
4. Press **ESC** key (or the smart icon ) to quit without saving any modification.

#### 5.3.4.5. Average value option

This option, **available for 4-wire systems only**, permits to display the arithmetic average of TRMS values of phase voltages V1, V2, V3, phase currents I1, I2, I3, active powers on each phase P1, P2, P3, absorbed, generated, inductive and capacitive reactive powers on each phase

The result is shown on Page 9/9 of numerical TRMS value (see Fig. 35).

1. Move the cursor using arrows keys on field relative to "**Average values**" , marked it with blue background.
2. Use **F3** or **F4** keys (alternatively touch **MOD(+)** o **MOD(-)**) to select one of below options:
  - ✓ **YES**: the meter shows the page 9/9 of average values inside Real Time Values section only for 4-wire systems.
  - ✓ **NO**: the meter does not shows the page 8/8 of average values inside Real Time Values section
3. Press **SAVE** or **ENTER** keys (or the smart icon ) to save the selected option and confirm by "Ok". This selected parameter will be present also the turn off of meter.
4. Press **ESC** key (or the smart icon ) to quit without saving any modification.

## 5.4. RECORDING SETTINGS



Fig. 69: Recording Settings screen selection

In this section the meter permits to define any detail relative to start and stop of recordings, perform parameters selection for recording, the type of analysis to be carried out very easily thanks to “touch screen” display. The use of smart icons and is particularly recommended in this section.

### 5.4.1. Recorder setting screen – PV systems

This screen is thought on different levels and sub-levels with a tree structure just like that of the Windows function My Computer, so that the desired options are reached in a very detailed way. After selecting icon “Recording configuration” of , the instrument shows the following screen:

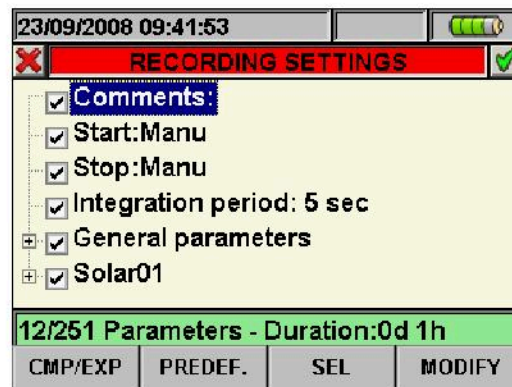

Fig. 70: Example of Recording screen for Photovoltaic systems setting

By using the up and down arrow keys, or directly from the display, it is possible to highlight the different internal items and to select/deselect the flags inside the check boxes. Next to the check boxes with the “+” symbol, the group expands, opening a sub-level where it is possible to carry out new selections. By pressing on the check box with the “-” symbol, you go back to the upper level. Selection/deselection is visually indicated on the display, as a help to the user, in the following way:

- **Grey** text and empty check box → Completely deselected group
- **Black** text and empty check box → Partially selected group
- **Black** text and selected check box → Completely selected group

From the display, it is also possible to use the scroll bar located fully on the right. The bar at the bottom of the display includes the following functions, which correspond to keys **F1**, **F2**, **F3**, **F4**:



- Function **CMP/EXP**: used to compress / expand the sub-levels (the left and right arrow keys have the same function)
- Function **PRESET**: used to open the preset configuration section (see § 5.4.2.14)
- Function **SEL**: used to select/deselect parameters in different levels.
- Function **MODIFY**: used to make any modification inside the levels.

On the bottom of the display, the instrument displays the **Recording autonomy** in terms of hours and days, which dynamically updates according to the parameter selections made.

#### 5.4.1.1. Item Comments

This option allows inserting and/or modifying a comment line on the display, in order to identify the type of analysis, which will also appear in the print report downloaded onto the PC by the instrument. A comment can be set both by means of the supplied TopView software (for information, please refer to the help on line of the software) and interactively using the virtual keyboard which can be activated by pressing the **F4** key (or item **MODIFY** on the display). The flag of this voice is always active and cannot be deselected.

#### 5.4.1.2. Use of the virtual keyboard

With the **Comments** item: highlighted in blue, press the **F4** key (or item **MODIFY** on the display). The following screen of the virtual keyboard is shown on the display:



Fig. 71: Virtual keyboard screen

The following table reports the description of the keys of the virtual keyboard:

Keys	Description
a, b, c, ... z	Standard alphabetic keyboard for typing in the comment in small letters up to <b>25 characters</b>
Cap	Changes the keyboard to capital letters A÷Z
123	Changes the keyboard with numeric characters 0÷9 and symbols for mathematical operations (+, -, *, /, .., =)
Sb	Group of special characters. Press "abc" to go back to alphabetic display.
àž	Group of special characters with particular accents. Press "abc" to go back to alphabetic display.
<-	Backspace key to delete the digit on the left of the cursor

Table 1: Description of function keys of the virtual keyboard



### 5.4.1.3. Items Start and Stop

This item determines the activation and deactivation mode of the recordings which can be made with the instrument (see § 5.6).

For PV systems, the start mode is set to "Manual" (**Manu**) and cannot be changed: Recording will therefore started/stopped only manually by pressing the **GO/STOP** key.

### 5.4.1.4. Item Integration period

This item allows setting the integration period (see § 10.11.1), that is to say the time interval between two consecutive recordings in the whole measurement campaign. The flag of this voice is always active and cannot be deselected.

1. Move the cursor on "**Integration period**" by means of the up or down arrow keys, so that it is highlighted in blue.
2. Press the **F4** key (or the **MODIFY** item on the display). At the bottom of the display, the instrument shows a control bar with the item "Integration period" highlighted.
3. Press the **F3** key (**MOD(+)**) or **F4** (**MOD(-)**) or the up or down arrow keys to set the desired integration period, choosing between the following values: **1s, 5s, 10s, 30s, 1min, 2min, 5min, 10min, 15min, 30min, 60min**.
4. Press the **SAVE** or **ENTER** key (or the smart icon ) to save the setting made. The set integration period is shown on the display.

### 5.4.1.5. Item General Parameters for use with SOLAR01 or SOLAR02 units

This item allows selecting the desired electrical mains parameters to be recorded. This level includes different internal sub-levels, in which a detailed definition is possible, according to the type of electric system (see § 5.3.1).

According to the selections made, the instrument displays the following informations:

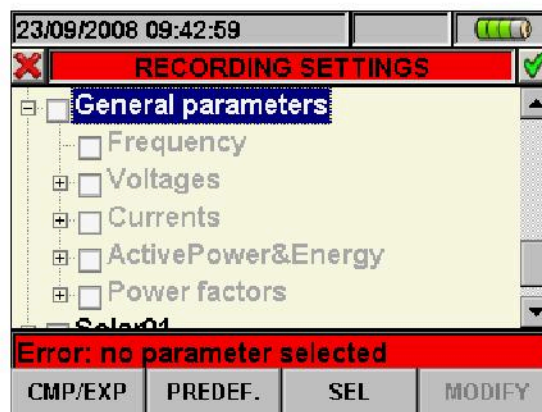

Fig. 72: Section General Parameters: no selection

Fig. 98 shows the situation in which the instrument shows the "no parameter selected" error, although it has highlighted item "General Parameters" on the display.

Note the writing on grey background and the unselected check box.

To exit, press the **F3** key (or the "**SEL**" item on the display).

In this case, a selection flag will appear next to item "General Parameters" and the previous situation will change to the following screen with text on black ground and selected check box:

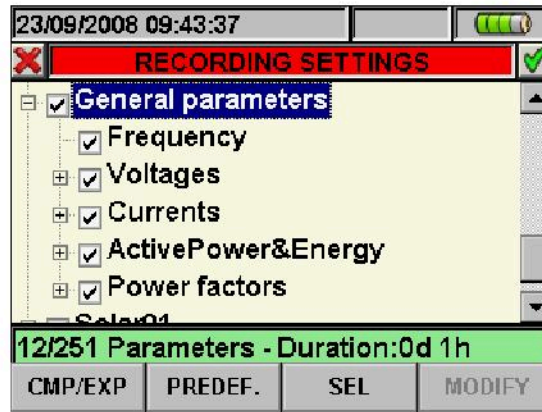

Fig. 73: Section General Parameters: selected parameters

As a consequence of the operation, in the example shown in Fig. 85, 12 electric parameters have been selected against a total of 251 available and the instrument automatically provides the recording autonomy with the current settings.



### CAUTION

The activation of the flag of item "General Parameters" involves the automatic selection of the main parameters of the mains, whose number varies according to the electric system being considered (Voltages, Currents, Frequency, Power Factors, Active Powers, Active Energies). Deselection of the item "General Parameters" also involves the automatic deselection of the above-mentioned items.

#### 5.4.1.6. Description of the sub-levels of item General Parameters

Press the **F1** key (**CMP/EXP** on the display) or the right or left arrow keys to expand or compress the sub-levels. The quantities shown in the sub-levels are closely related to the type of system considered and selected (see § 5.3.1). In the figures shown below, the different situations which may occur are shown:

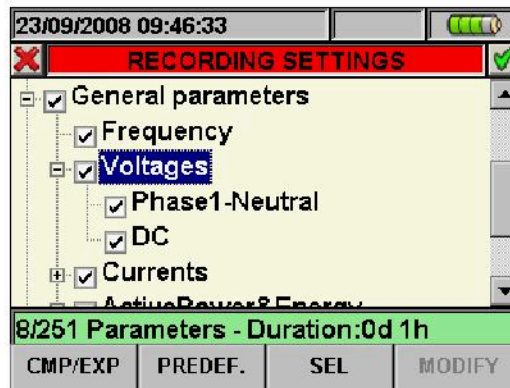



Fig. 74: Sub-level General Parameters – Single-Phase Photovoltaic System

Each parameter can be selected fully **independently** from the others. The following quantities are considered for recordings in single-phase photovoltaic systems:

Parameter	Description
Frequency	Frequency of phase L1
AC voltage	TRMS voltage L1-N downstream the inverter
DC voltage	DC voltage upstream the inverter
AC current	TRMS current of phase L1 downstream the inverter
DC current	DC current upstream the inverter
Active power and active energy	Active power and active energy DC and on phase L1
Power factor	Power factor on phase L1

Table 2: Parameters which can be selected for a single-phase photovoltaic system

Press the **SAVE** or **ENTER** key (or the smart icon ) to save each setting made. In this situation, the instrument shows a window to confirm the saving. Press “Ok” in the window to confirm. Once the operation is completed, the instrument goes back to the general menu screen. To quit the settings made or to exit without saving, press the **ESC** key (or the  icon).

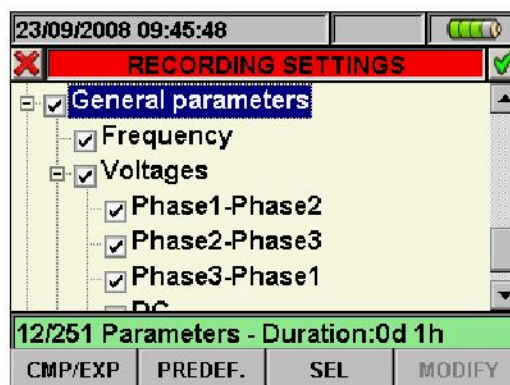



Fig. 75: Sub-level General Parameters – Three-Phase Photovoltaic System

The following quantities can be selected for recordings in three-phase photovoltaic systems:



Parameter	Description
Frequency	Frequency of phases L1, L2, L3
AC voltages	TRMS voltages L1-L2, L2-L3, L3-L1 downstream the inverter
DC voltage	DC voltage upstream the inverter
Current	TRMS currents L1, L2, L3 downstream the inverter
DC currents	DC current upstream the inverter
Active power and active energy	Total DC and AC active power and active energy
Power factor	Total power factor

Table 3: Parameters which can be selected for a three-phase photovoltaic system

Press the **SAVE** or **ENTER** key (or the smart icon ) to save each setting made. In this situation, the instrument shows a window to confirm the saving. Press "Ok" in the window to confirm. Once the operation is completed, the instrument goes back to the general menu screen. To quit the settings made or to exit without saving, press the **ESC** key (or the smart icon )

#### 5.4.1.7. Item SOLAR-01 and SOLAR-02

By selecting this item, both by means of the **F3** key when the cursor is positioned on item **SOLAR01** or **SOLAR02**, and directly selecting the flag on the display, inserts the value of parameters **Irradiation**, **Cell Temperature**, **Environmental Temperature** into the list of quantities for recording.

#### 5.4.1.8. Default settings

The instrument allows to select the predefined DEFAULT configuration which is always used during any test on PV installation. The instrument allows the user to define **up to 16 custom settings**, which can be saved and called by the user at all times. The selection of these settings automatically sets on the instrument **only** the parameters necessary for carrying out the recording or the ones selected by the user.

In any screen of section "Recording configuration", press the **F2** key (or select item **PREDEF.** on the display). The instrument displays the following screen:



Fig. 76: Default setting screen

Select the desired setting by means of the up or down arrow keys and press the **SAVE** or **ENTER** keys (or the smart icon ) to save the setting. The instrument shows the message "Do you want to change the recording configuration?", which must be confirmed with "Ok". The instrument automatically selects the parameters and the recording autonomy.

To add a custom default setting, press the **F1** key (or item **AGG** on the display). The instrument shows the message "Do you want to save current configuration?", which must be confirmed with "Ok", and automatically activates the virtual keyboard (see § 5.4.2.2) in which it is possible to define and save the custom name. Once this operation has ended, the instrument shows the following screen:

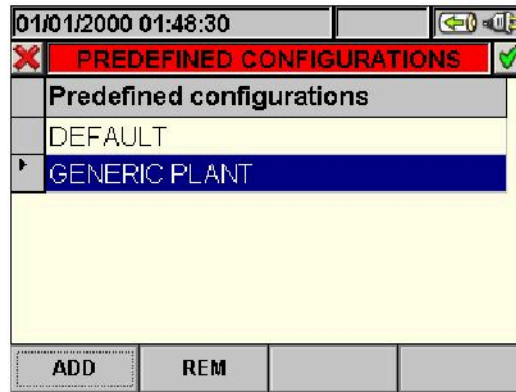

Fig. 77: Custom setting screen

In the example above, the custom setting “GENERIC PLANT” has been created and can be loaded by pressing the **SAVE** or **ENTER** keys (or smart icon ). This setting can be deleted at all times by pressing the **F2** key (or item **CANC** on the display). The instrument shows the message “Do you want to change the selected configuration?”, which must be confirmed with “Ok”, to complete the operation.

To quit the settings made or to exit without saving, press the **ESC** key (or the smart icon ). The list below contains the parameters selected by the instrument for each typical configuration:

DEFAULT CONFIGURATION (PV systems)			
GENERAL MENU SECTION	PARAMETER	SETTING	
Photovoltaic configuration - Param	Pnom[W]	Not modified	
	Te[°C]		
	Tc[°C]		
	Y[%°C]		
	NOCT[°C]		
Photovoltaic configuration - Advanced	Pyranometer [mV/(kW/m <sup>2</sup> )]		
	Irr. Min [W/m <sup>2</sup> ]		
	K Clamp Dc		
Recording configuration	Comments		DEFAULT
	Start		Manu
	Stop	Manu	
	Integration period	5 sec	
	General Parameters	PV-1 system	Hz, V1N, VDC, I1, IDC, P1, Ea1, PDC, EaDC, Pft1
		PV-3 system	Hz, V12, V23, V31, VDC, I1, I2, I3, IDC, Pt, Eat, PDC, EaDC, Pft
	SOLAR-0x	Irradiation, Cell Temperature, Environmental Temperature	

Table 4: Parameters set in DEFAULT configuration



### CAUTION

The DEFAULT configuration defines the parameters selected on the instrument by the manufacturer. Each subsequent modification made and saved by the user in section “Analyzer setting” changes this configuration with the new selections, which can differ from the initial ones.

#### 5.4.1.9. Item General Parameters for use with MPP300 unit

After setting MPP300 as remote unit (see § 5.3.3) the instrument will display a selection tree, in which it will be possible to change only the “comment” fields and the value of the integration period.

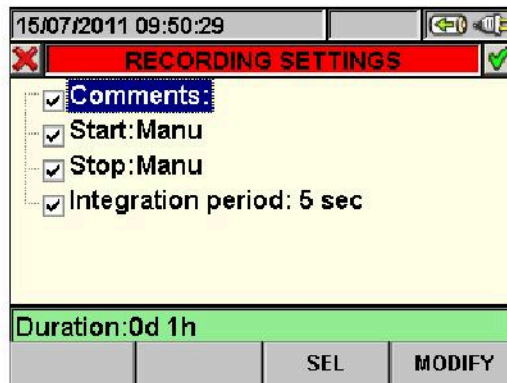



Fig. 78: Section of General Parameters: no selection

The list of the recorded quantities cannot be changed and is only related to the number of DC inputs set (MPPT) and to the type of electric system at the inverter output (single-phase or three-phase).

PV systems with MPP300			
GENERAL MENU SECTION	PARAMETER	SETTING	
Recording configuration	Comments	(empty)	
	Start	Manu	
	Stop	Manu	
	Integration period	5 sec .. 60min	
	General Parameters	MPP300-1 system	VDCx, IDCx, PDCx, Hz, V1N, I1, P1, Ea1
		MPP300-3 system	VDCx, IDCx, PDCx, PDCtot Hz, V1N, V2N, V3N, V12, V23, V31, I1, I2, I3, P1, P2, P3, Ptot, Ea1, Ea2, Ea2, Eatot
SOLAR-02	Irradiation, Celle Temperature, Environmental Temperature		

x = 1,2,3 according to the number of DC inputs (MPPT) set.

Press the **SAVE** or **ENTER** keys (or the smart icon ) to save each selected setting. In this condition, the instrument shows a window to confirm the saving. In this window, confirm by pressing “Ok”. Once the operation has been completed, the instrument goes back to the general menu screen.

To quit the modifications made or to exit without saving, press the **ESC** key (or the smart icon )



### 5.4.2. Recording settings screen – NPV systems

This screen is designed with some levels and sub-levels as a typical tree Windows structure in order to reach with extreme details the desired options. After selection of “Recording settings” icon, the below screen is shown:

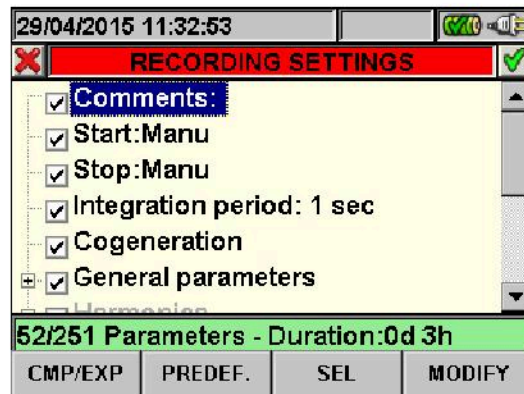

Fig. 79: Recording settings screen

Using up and down arrows keys or touching directly the items at display the selection/disable of internal flags inside check box is possible. Click on check box with “+” symbol to cause an expansion of structure with the opening of a new sub-level inside which new selections are possible. Click on check box with “-” symbol to go back to master level. The displayed selection/disable of parameters is performed in the following way:

- **Grey** text and empty check box → Node completely disabled
- **Black** text and empty check box → Node partially selected
- **Black** text and selected check box → Node completely selected

The bottom bar of display included the below functions, relative to **F1**, **F2**, **F3**, **F4** keys:

- **CLP/EXP**: used to collapse or expand the sub-levels
- **PREDEF.**: used to open the typical configuration section (see § 5.4.2.14)
- **SEL**: used to select or disable parameters inside various levels
- **MODIFY**: used to perform any parameters modify inside various levels

On the bottom of display the number of selected parameters and the **recording autonomy**, expressed in days and hours, is shown by meter. These s are dynamically updated from meter depending on the parameters selection.

#### 5.4.2.1. Comments

This option permits to insert a short comment row at display which will compare also in print report downloaded from meter to PC. This comment text is set both using standard TopView software (for any information please refer to software Help on line) and by using the virtual keyboard on meter which is activated by pressing **F4** key (or the **MODIFY** at display). The flag of this option is always active and not disabled.

### 5.4.2.2. Use of virtual keyboard

With the **Comments:** marked in blue background at display press **F4** key (or the **MODIFY** at display). The below screen is shown at display:

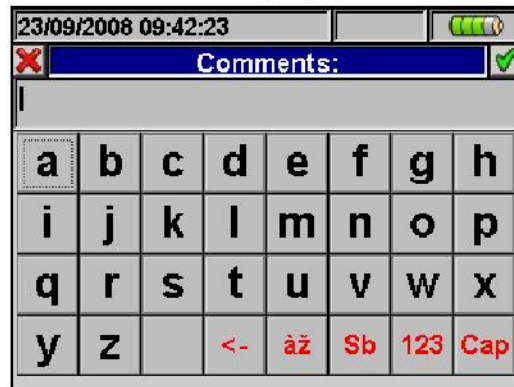

Fig. 80: Virtual keyboard screen

The keys' description of the above keyboard is shown in the below table:

Keys	Description
a, b,c,...z	Standard small letters keyboard for digit comments up to <b>25 characters</b>
Cap	Capital letters keyboard A÷Z is shown
123	Numerical 0÷9 besides mathematic operation symbols (+,-,*,/,.,=) keyboard is shown
Sb	Special symbols keyboard is shown. By pressing "abc" key to go back to standard small letter keyboard.
àž	Special symbols with special stress keyboard are shown. Press "abc" key to go back to standard small letter keyboard.
<-	Backspace key to cancel character on the left of the cursor

Table 5: Description of function key of virtual keyboard

### 5.4.2.3. Start and Stop

These items permits to define the method to enable and disable the recordings with meter (see § 5.6). The possible options are:

- **Manu:** each recording is enabled/disabled in MANUAL mode by pressing **GO/STOP**
- **Auto:** each recording is enabled/disabled in AUTOMATIC mode, starting from a setting and valid date/hour **by preliminary pressing of GO/STOP** key

The default configuration is always the MANUAL mode and the flags of these s are not disable. To change from MANUAL mode to AUTO mode performs the below steps:

1. Move the cursor using arrows keys on the field relative to "**Start:Manu**" or "**Stop:Manu**", marked with blue background
2. Press **F4** key (alternatively touch the **MODIFY** at display). In the bottom of display a command bar with "Manu" is shown.
3. Press **F3** key (**MOD(+)**) or **F4(MOD(-))** and select "**Auto**"
4. Use left or right arrows keys to moving on date and hour fields. Using the up arrow key or **F3 (MOD(+))** key to increase the value and the down arrow key or **F4 (MOD(-))** key to decrease the value
5. Press **SAVE** or **ENTER** keys (or the smart icon ) to save the settings. The Automatic mode and the set date/hour are shown at display.

#### 5.4.2.4. Integration period

This option permits to set the integration period (see § 10.11.1) which is the time interval between two sequential recordings within the global duration of measurements. The flag of this option is always active and not disabled.

1. Move the cursor using arrows keys on field relative to “**Integration period**” , marked it with blue background.
2. Press **F4** key (alternatively touch the **MODIFY** at display). In the bottom of display a command bar with “Integration Period” is shown.
3. Press **F3** key (**MOD(+)**) or **F4(MOD(-))** or up and down keys to set the desired integration period choosing among the below values: **1s, 5s, 10s, 30s, 1min, 2min, 5min, 10min, 15min, 30min, 60min**.
4. Press **SAVE** key or **ENTER** key (or the smart icon ) to save the settings. The integration period value is shown at display.

#### 5.4.2.5. Cogenerations

The selection of this , effected both by using up or down arrows keys and directly selecting the flag at display, enters the values of powers and energies generated (co-generation) in the list of recorded parameters (see § 10.10.1)



#### 5.4.2.6. General Parameters

This option permits the selection of network parameters for recording operation. This level included several sub-level for a detailed selection depending on the type of system on test (see § 5.3.1).

Depending on the selection performed, different error screen can be shown by meter. The below situations are possible:

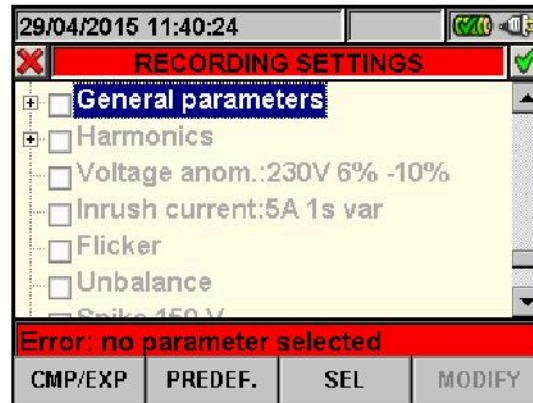

Fig. 81: General Parameters section: no selection

Fig. 81 shows the situation which the error due to no parameters selection is performed also if the “General Parameters” is selected at display. Please note the text on grey background and the not selected check box. In this situation other type of analysis as Harmonics, Voltage Anomalies, Flicker, etc.. are not possible. Pressing **F3** key (or touch “**SEL**” at display) to exit from this error condition. In this order the flag of “General Parameters” check box it will be selected and the below screen (with black text background) is shown:



Fig. 82: General Parameters section: selected parameters

In example of the above Fig. 82, 32 parameters are been selected on total of maximum **251 available** and the correspondent autonomy is shown automatically by meter in this case.



### CAUTION

The “General Parameters” check box activated flag, automatically select the main electrical parameters whose number depends on the selected system (Voltages, Currents, Frequency, Power Factor, Active, Reactive, Apparent Powers, Active, Reactive, Apparent Energies). The failure to select “General Parameters” flag automatically do not select the above parameters.

The opposite situation is the error due to a too many selected parameters. In this case the below screen is shown:



Fig. 83: General Parameters section: too many selected parameters

In the above screen the harmonics' selection brought about too many selected parameters (more than 251). Not select some parameters to quit this situation.

### CAUTION

The choose of a electrical for recording often increase the number of selected parameters more than one unit only. In particular:

- Frequency → 1 selected parameter.
- Voltage → from 1 to 7 selected parameter depend on system.
- Current → from 1 to 4 selected parameter depend on system.
- Powers and Energies → from 1 to 8 selected parameter depend on system and Cogenerations.
- Power Factor → from 1 to 8 selected parameter depend on system and Cogeneration.
- Harmonics: THD and DC → from 1 to 8 selected parameter depend on system.
- Harmonics Odd → from 25 to 100 selected parameter depend on system.
- Harmonics Even → from 24 to 96 selected parameter depend on system.
- Voltage Anomalies → no selected parameters.
- Flicker → from 1 to 3 selected parameter depend on system.
- Unbalance → 1 selected parameter.



#### 5.4.2.7. General Parameters: sub-levels description

Press **F1** key (or touch **CLP/EXP** at display) to expand or compress the sub-levels. The parameters inside sub-levels are strictly depending on type of selected system (see § 5.3.1). As an example, below are shown the screens relative to a **three phase 4-wire system**. Similar consideration can be applied to any other selected system

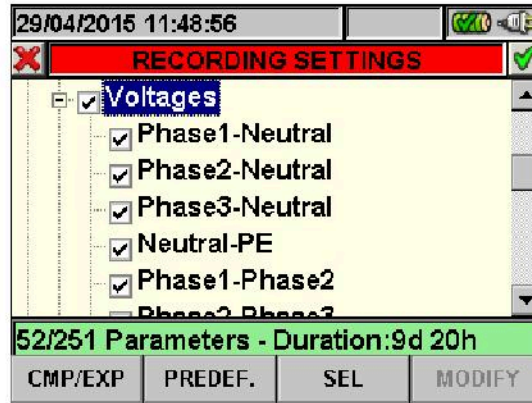



Fig. 84: General Parameters sub-level - Three phase 4-wire system

Each parameter is always selectable **independent** from others. The below parameters can be selected for recording in Single phase systems:

Parameters	Description
Frequency	Frequency of phases L1, L2, L3
Voltages	TRMS voltages L1-N, L2-N, L3-N, N-PE TRMS voltages L1-L2, L2-L3, L3-L1
Currents	TRMS currents L1, L2, L3, Neutral
Active Power & Energy	Active power and energy L1, L2, L3, Total
Reactive Power & Energy	Reactive (inductive or capacitive) power and energy L1, L2, L3, Total
Apparent Power & Energy	Apparent power and energy L1, L2, L3, Total
Power Factor	Power factor L1, L2, L3 Total
CosPhi	Power factor referred to fundamental of voltage and current L1, L2, L3, Total

Table 6: Selectable parameters for Single phase system

Press **SAVE** or **ENTER** keys (or the smart icon ) to save each selection and confirm by "Ok". The main screen of is shown by meter at the end of the operation. Press **ESC** key (or the smart icon ) to quit without saving and back to previous screens.



#### 5.4.2.8. Harmonics: sub-levels description

Press **F1** key (alternatively touch **CLP/EXP** at display) to expand or compress the harmonics sub-levels. The parameters inside sub-levels are strictly depending on type of selected system (see § 5.3.1). Below there are some pictures of different possible situations:

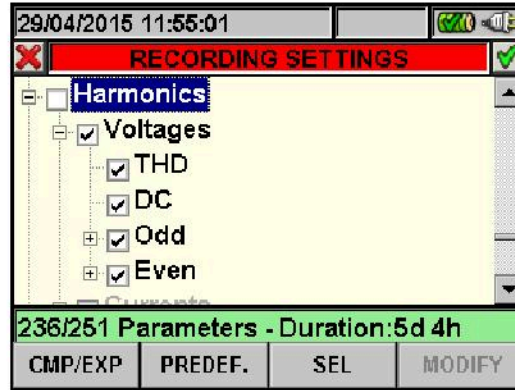

Fig. 85: Harmonics sub-levels: initial parameters selection

Inside Harmonics level there is another sub-level where an accurate selection of harmonic parameters is possible. Move the cursor on “**Odd**” or “**Even**” using arrows key and press **F1** key (or touch **CLP/EXP** at display). The result, referred to Odd harmonics is below shown:

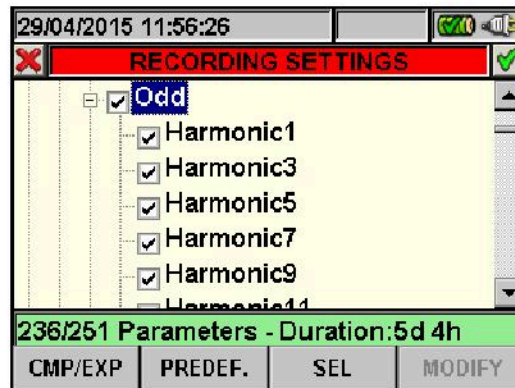

Fig. 86: Harmonics sub-levels: odd harmonics selection

Press **F3** key (alternatively touch **SEL** at display) to select/unselect the desired parameters. The number of selected and recording autonomy are automatically updated from meter. The below harmonic parameters can be selected for recording (see § 10.5):

Press **SAVE** or **ENTER** keys (or the smart icon ) to save each selection and confirm by “Ok”. The main screen is shown by meter at the end of the operation. Press **ESC** key (or the smart icon ) to quit without saving and back to previous screens.

The selection parameters of harmonic analysis **require** the preliminary selection of voltages or currents inside General Parameter sub-level. The below error screen are shown in these cases:

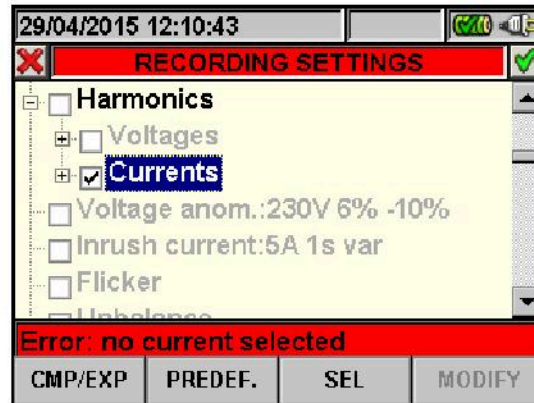

Fig. 87: No selected currents error screen

To solve the error situation of above screen select the “Current” inside “General Parameter” sub-level (see § 5.4.2.7).

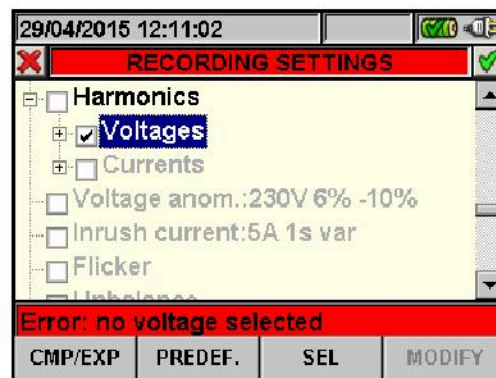

Fig. 88: No selected voltages error screen

To solve the error situation of above screen select the “Voltages” inside “General Parameter” sub-level (see § 5.4.2.7)

#### 5.4.2.9. Voltage Anomalies

This option permits to set the control parameters relative to voltage anomalies (sags, swell, supply breaks – see § 10.4) recording which is completely **independent** from periodic analysis (regulated by integration period). The below screen is shown by meter:

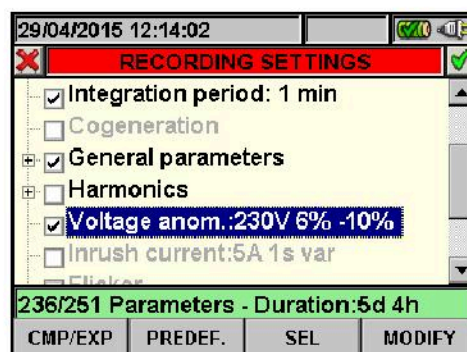

Fig. 89: Voltage Anomalies selection screen

Press **F4** key (alternatively touch **MODIFY** at display) for setting the below voltage anomalies parameters:

- Reference nominal voltage **Vref** depending on the type of considered system. In particular **Vref = VP-N** (Single phase and three phase 4-wire systems), **Vref = VP-P** (three phase 3-wire and ARON systems).
- The higher threshold percentage of reference nominal voltage, selectable from **1%** to **30%** for voltage swell detection.
- The lower threshold percentage of reference nominal voltage, selectable from **1%** to **30%** for voltage sags or breaks detection.

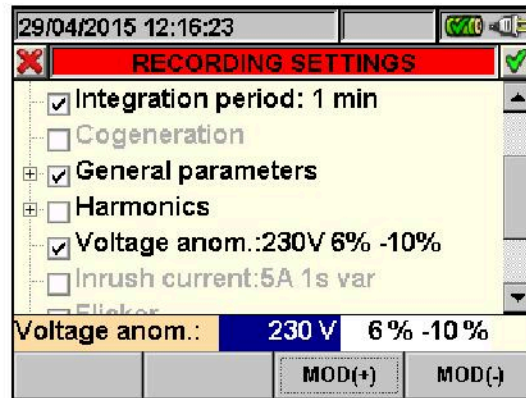



Fig. 90: Voltage Anomalies screen - setting control parameters

1. Move the cursor using arrows keys on field relative to "**Voltage Anom.**", marked it with blue background.
2. Use up or down arrow keys or press **F3** or **F4** keys (alternatively touch the **MOD(+)** or **MOD(-)** s at display) to setting the correspondent value. Pressing and holding of these keys permits a rapid values setting, while the single pressure increase or decrease on only unit the value. Use left or right arrow keys to move on various fields.
3. Press **SAVE** or **ENTER** keys (or the smart icon ) to save each performed setting.

### CAUTION



The nominal reference value should be set depending on the type of considered system on test and the measured voltage. A message "**Wrong Vref voltage anomalies**" at the recording start is shown by meter which do not permits the recording operation due to this wrong configuration (e.g.: 4-wire system and Vref = 400V). Set the correct value in this case.



#### 5.4.2.10. Inrush current

This option permits to set the control parameters relative to recording of inrush current events (see § 10.6) which is completely **independent** from periodic analysis (regulated by integration period). The below screen is shown by meter:

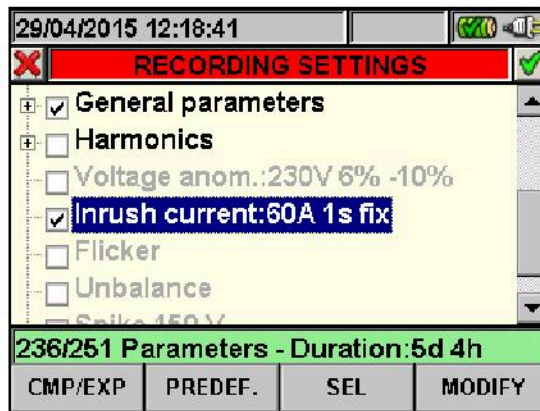



Fig. 91: Inrush currents selection screen

Press **F4** key (alternatively touch **MODIFY** at display) to set the below parameters for recording of inrush currents:

- The value of current threshold which is correspondent to detection and recording of inrush current event from meter. This value cannot exceeded the full scale which is selected for the clamp type used for current measurements (see § 5.3.1.3).
- The value of the inrush current detection time interval expressed in seconds. Possible values which can be set are **1s**, **2s**, **3s** and **4s**.
- The detection type of inrush currents events. The **fix** mode (the event is detected whenever the input current value is over the set threshold) or **var** mode (the event is detected if the difference between two instantaneous values in a half period exceed the set threshold) are possible.



Fig. 92: Inrush current screen - setting control parameters

1. Move the cursor using arrows keys on field relative to **"Inrush current"** , marked it with blue background.
2. Use up or down arrow keys or press **F3** or **F4** keys (alternatively touch the **MOD(+)** or **MOD(-)** s at display) to set the correspondent value. Pressing and holding these keys permits a rapid values setting, while the single pressure increases or decreases the value by one single unit. Use left or right arrow keys to move on various fields.
3. Press **SAVE** or **ENTER** keys (or the smart icon ) to save each performed setting

### 5.4.2.11. Flicker

This option permits to set control parameters relative to flicker value recordings on the input voltages in compliance to EN 61000-4-15 and EN 50160 standards (see § 10.7). In particular the below parameters are shown by meter:

- Pst1' = short term severity at 1 min; Pst = short term severity for all recording duration.
- Plt = long term severity for all recording duration.

The below screen is shown:

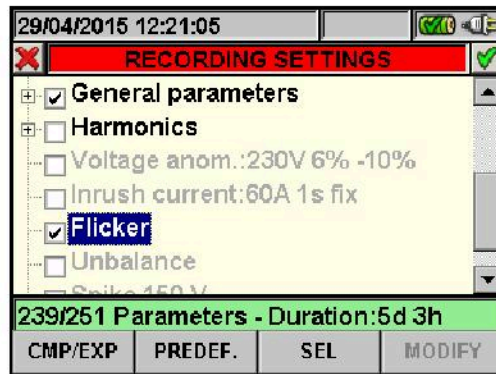

Fig. 93: Flicker setting screen

For flicker recording at least one voltage selection and a correct integration period are necessary conditions. In particular if no voltage are selected the below screen is shown:

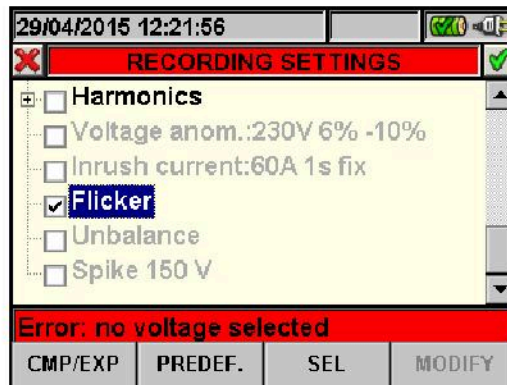

Fig. 94: Flicker setting screen - no selected voltage

See the § 5.4.2.6 to exit from this error situation. In case of integration period setting value less of 1 minute or higher to 15 minutes the below error screen is shown by meter:

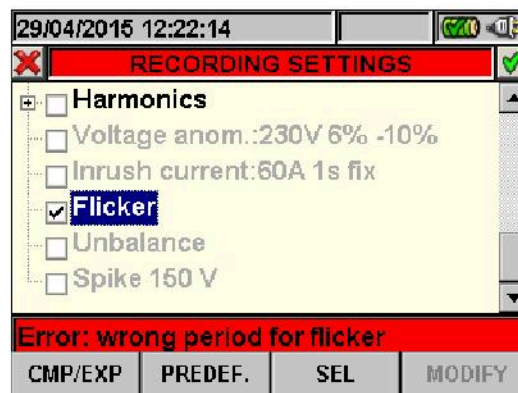

Fig. 95: Flicker setting screen - wrong period for flicker

See the § 5.4.2.4 to exit from this error situation. Press **SAVE** or **ENTER** keys (or the smart icon ) to save each selection and confirm by "Ok" . The main screen is shown by meter at the end of the operation. Press **ESC** key (or the smart icon ) to quit without saving and go back to previous screens.



#### 5.4.2.12. Unbalance

The selection of this option include on selected parameters list for recording the value of **NEG%** and **ZERO%** s which are index of unbalance of input voltage signal respective to negative tern and zero term (see § 10.8). “Unbalance” is not shown for single phase systems.

#### 5.4.2.13. Spike

This option permits to set the control parameters relative to recording of voltage fast transients (spike) events (see § 10.9) with  $5\mu\text{s}$  resolution which is completely **independent** from periodic analysis (regulated by integration period). The below screen is shown by meter:

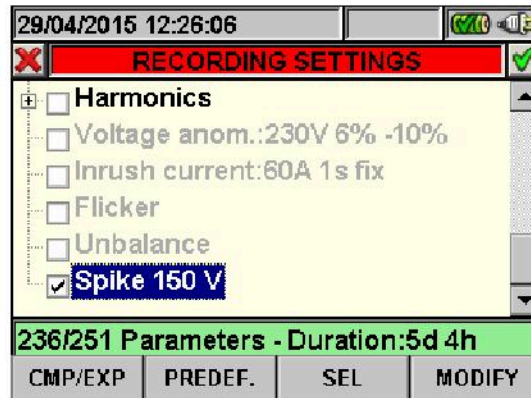

Fig. 96: Spike setting screen

Press **F4** key (alternatively touch **MODIFY** at display) for setting the parameter for detection and recording of voltage spikes. In particular is possible to set:

The value of voltage threshold to detection and recording the voltage spike event from meter. This value s selectable from **100V** and **5000V** value.

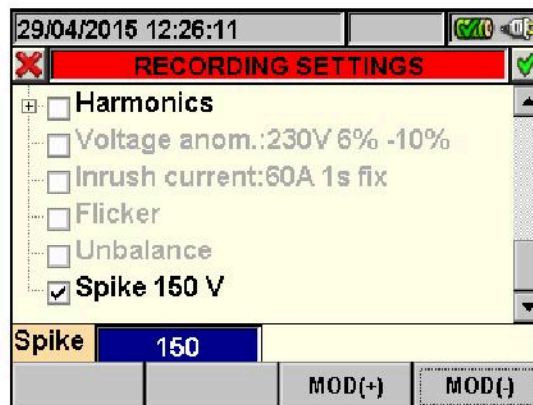



Fig. 97: Spike screen - setting control parameter

1. Move the cursor using arrows keys on field relative to “**Spike**” , marked it with blue background.
2. Use up or down arrow keys or press **F3** or **F4** keys (alternatively touch the **MOD(+)** or **MOD(-)** s at display) to set the correspondent value. Pressing and holding of these keys permit a rapid values setting, while the single pressure increase or decrease on only unit the value.
3. Press **SAVE** or **ENTER** keys (or the smart icon ) to save each performed setting.



#### 5.4.2.14. Predefined configurations

In order to make the recording start easier the meter includes 3 selectable predefined configurations which describe typical situation in electrical installations, besides a "Default" configuration which defines the initial settings from the factory. The meter also permits to define up to **16 free configuration** which can be customized, saved and recalled by user at any time. The selection of one of these configurations automatically sets **only the necessary** parameters for recording operation under that circumstance. The predefined configurations are:

1. **DEFAULT**: setting parameters of default configuration from the exit of meter by factory
2. **EN50160**: Setting parameters for networks quality recording (voltage anomalies, harmonics, flicker , unbalance and spikes in compliance to EN 50160 standard (see § 10.5.2)
3. **VOLTAGE ANOMALIES**: configuration of the parameters for mains quality regarding voltage anomalies (dips, peaks, interruptions – see § 10.4)
4. **HARMONICS**: configuration of the parameters for voltage and current harmonic analysis (see § 10.5)
5. **INRUSH**: Setting parameters inrush current events detection
6. **POWER & ENERGY**: configuration of the parameters regarding Power and Energy measurement (see § 10.10)

Pressing **F2** key (or touch **PREDEF.** at display) in any "Recording Settings" screen. The meter show the below screen:

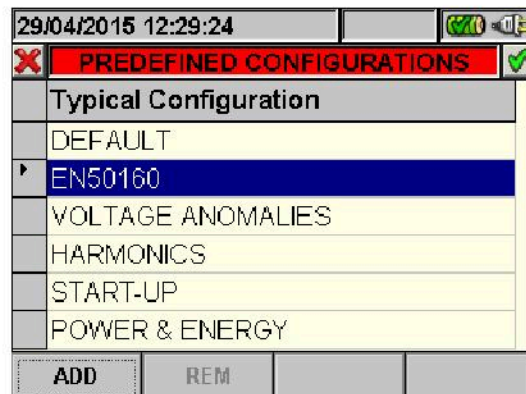



Fig. 98: Typical configuration screen

Select the desired typical configuration using up or down arrow keys or touch display. Press **SAVE** or **ENTER** keys (or the smart icon ) to save the desired selection. The warning message "**Change recording setting?**" is shown by meter. Press "Ok" to confirm. The meter automatically sets the parameters and updated the recording autonomy at display.

To add a predefined customized configuration press the **F1** key (or the **ADD** at display). The warning message "**Add actual configuration**" is shown by meter. Press "Ok" to confirm and activate automatically the virtual keyboard (see § 5.4.2.2) where it's possible to define and save the configuration name by user. At the end of these operations the following screen is shown by meter:

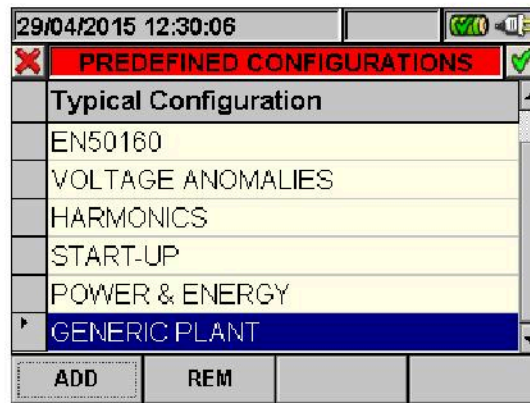



Fig. 99: Typical customized configuration screen

The typical customized configuration called e.g. "GENERIC PLANT" was defined and can be loaded by pressing the **SAVE** or **ENTER** keys (or the smart icon ). This configuration can be removed in any time by pressing **F2** key (or the **REM** at display). The warning message "**Delete selected configuration?**" is shown by meter. Press "Ok" to complete the operation. Please note that the 5 predefined configuration and the DEFAULT configuration **cannot** be removable by user.

Press **ESC** (or the smart icon ) to quit without saving any modify. Below the selected parameters for each of predefined configuration are shown:

EN50160			
MENU GENERAL	PARAMETER	SETTINGS	SYSTEM
Analyzer Settings	System	Not modified	Each system
	Freq[Hz]		
	Clamp Type		
	FS Clamp[A]		
	VT Ratio		
Analyzer Settings - Advanced	Zoom Graphics		
	Harm. Type		
	Harm. Values		
	Zoom 1st Harm.		
	Average Values		
Recording Settings	Comments	EN50160	Each system
	Start	Not modified	
	Stop	Not modified	
	Integration period	10min	
	Cogeneration	OFF	
	General Parameters	V1N, Hz	Single phase
		V12,V23, V31, Hz	ARON
		V1-PE, V2-PE, V3-PE V12, V23, V31, Hz	3-wire
		V1N, V2N, V3N, Average (if activated), Hz	4-wire
	Voltage harmonics	THD, DC, h1, h2, h3...h25	Each system
	Current harmonics	OFF	
	Voltage anomalies	ON	
	Ref. Voltage anomalies	230V	Single, 4-wire
		400V	3-wire, ARON
	Up threshold anomalies	+6%	Each system
	Low threshold anomalies	-10%	
	Inrush current	OFF	
	Flicker	ON	
	Unbalance	Not available	Single phase
		ON	3/4-wire, ARON
Spike	ON (150V)	Each system	

Table 7: Selected parameters of EN50160 configuration



VOLTAGE ANOMALIES			
MENU GENERAL	PARAMETER	SETTINGS	SYSTEM
Analyzer Settings	System	Not modified	Each system
	Freq[Hz]		
	Clamp Type		
	FS Clamp[A]		
	VT Ratio		
Analyzer Settings - Advanced	Zoom Graphics		
	Harm. Type		
	Harm. Values		
	Zoom 1st Harm.		
	Average Values		
Recording Settings	Comments	VOLTAGE ANOMALIES	Each system
	Start	Not modified	
	Stop	Not modified	
	Integration period	1min	
	Cogeneration	OFF	
	General Parameters	V1N, VN-PE, Hz	Single phase
		V12, V23, V31, Hz	3-wire, ARON
		V1N, V2N, V3N, VN-PE, Average (if activated), Hz	4-wire
	Voltage harmonics	OFF	Each system
	Current harmonics	OFF	
	Voltage anomalies	ON	
	Ref. Voltage anomalies	230V	Single, 4-wire
		400V	3-wire, ARON
	Up threshold anomalies	+6%	Each system
	Low threshold anomalies	-10%	
Unbalance	Not available	Single phase	
	ON	3/4-wire, ARON	

Table 8: Selected parameters of VOLTAGE ANOMALIES configuration

HARMONICS			
MENU GENERAL	PARAMETER	SETTINGS	SYSTEM
Analyzer Settings	System	Not modified	Each system
	Freq[Hz]		
	Clamp Type		
	FS Clamp[A]		
	VT Ratio		
Analyzer Settings - Advanced	Zoom Graphics		
	Harm. Type		
	Harm. Values		
	Zoom 1st Harm.		
	Average Values		
Recording Settings	Comments	HARMONICS	Each system
	Start	Not modified	
	Stop	Not modified	
	Integration period	10min	
	Cogeneration	OFF	
	General Parameters	V1N, VN-PE, I1, Hz	Single phase
		V1-PE, V2-PE, V3-PE, V12, V23, V31 I1, I2, I3, Hz	3-wire
		V12, V23, V31 I1, I2, I3, Hz	ARON
		V1N, V2N, V3N, VN-PE, I1, I2, I3, IN (only PQA82x), Hz	4-wire
	Voltage harmonics	THD, DC, h1, h2, h3...h25	Each system
	Current harmonics	THD, DC, h1, h2, h3...h25	
	Voltage anomalies	OFF	
	Ref. Voltage anomalies	OFF	Single, 4-wire
		OFF	3-wire, ARON
	Up threshold anomalies	OFF	Each system
	Low threshold anomalies	OFF	
	Unbalance	Not available	Single phase
OFF		3/4-wire, ARON	

Table 9: Selected parameters of HARMONICS configuration

INRUSH				
MENU GENERAL	PARAMETER	SETTINGS	SYSTEM	
Analyzer Settings	System	Not modified	Each system	
	Freq[Hz]			
	Clamp Type			
	FS Clamp[A]			
	VT Ratio			
Analyzer Settings Advanced	Zoom Graphics			
	Harm. Type			
	Harm. Values			
	Zoom 1st Harm.			
	Average Values			
Recording Settings	Comments	INRUSH	Each system	
	Start	Not modified		
	Stop	Not modified		
	Integration period	1s		
	Cogeneration	OFF		
	General Parameters		V1N, VN-PE, I1, Hz	Single phase
			V1-PE, V2-PE, V3-PE, V12, V23, V31 I1, I2, I3, Hz	3-wire
			V12, V23, V31 I1, I2, I3, Hz	ARON
			V1N, V2N, V3N, VN-PE I1, I2, I3, IN (only PQA82x), Hz	4-wire
			P1, Q1i, Q1c, S1, Pf1, Cosphi1, Ea1, Eri1, Erc1	Single phase
			Pt, P1, P2, P3, Qti, Qti1, Qti2, Qti3, Qtc, Qtc1, Qtc2, Qtc3, St, S1, S2, S3, Pft, Pf1, Pf2, Pf3, Cosphit, Cosphi1, Cosphi2, Cosphi3, Eat, Eat1, Eat2, Eat3, Erit, Eri1, Eri2, Eri3, Erct, Erc1, Erc2, Erc3	3-wire, 4-wire
			Pt, P12, P32, Qti, Q12i, Q32i, Qtc, Q12c, Q32c, St, S12, S32, Pft, Pf12, Pf32, Cospht, Cosphi12, Cosphi32, Eat, Ea12, Ea32, Erit, Eri12, Eri32, Erct, Erc12, Erc32	ARON
	Voltage harmonics	THD, DC, h1, h2, h3...h15	Each system	
	Current harmonics	THD, DC, h1, h2, h3...h15		
	Voltage anomalies	ON	Single, 4-wire	
	Ref. Voltage anomalies	230V		
		400V	3-wire, ARON	
	Up threshold anomalies	+6%	Each system	
	Low threshold anomalies	-10%		
	Inrush current	ON (10A, 1s, var)		
Flicker	OFF	Single phase		
Unbalance	Not available			
	ON		3/4-wire, ARON	
Spike	OFF	Each system		

Table 10: Selected parameters of INRUSH configuration



POWER & ENERGY				
MENU GENERAL	PARAMETER	SETTINGS	SYSTEM	
Analyzer Settings	System	Not modified	Each system	
	Freq[Hz]			
	Clamp Type			
	FS Clamp[A]			
	VT Ratio			
Analyzer Settings Advanced	Zoom Graphics			
	Harm. Type			
	Harm. Values			
	Zoom 1st Harm.			
	Average Values			
Recording Settings	Comments	POWER & ENERGY	Each system	
	Start	Not modified		
	Stop	Not modified		
	Integration period	15min		
	Cogeneration	ON		
	General Parameters		V1N, I1	Single phase
			V1-PE, V2-PE, V3-PE, V12, V23, V31, I1, I2, I3, Hz	3-wire
			V12, V23, V31, I1, I2, I3, Hz	ARON
			V1N, V2N, V3N, V12, V23, V31, I1, I2, I3, IN (only PQA82x), Hz	4-wire
			P1, Q1i, Q1c, S1, Pf1, Cosphi1, Ea1, Eri1, Erc1	Single phase
			Pt, P1, P2, P3, Qti, Qti1, Qti2, Qti3, Qtc, Qtc1, Qtc2, Qtc3, St, S1, S2, S3, Pft, Pf1, Pf2, Pf3, Cosphit, Cosphi1, Cosphi2, Cosphi3, Eat, Eat1, Eat2, Eat3, Erit, Eri1, Eri2, Eri3, Erct, Erc1, Erc2, Erc3	3-wire, 4-wire
		Pt, P12, P32, Qti, Q12i, Q32i, Qtc, Q12c, Q32c, St, S12, S32, Pft, Pf12, Pf32, Cospht, Cosphi12, Cosphi32, Eat, Ea12, Ea32, Erit, Eri12, Eri32, Erct, Erc12, Erc32	ARON	
	Voltage harmonics	OFF	Each system	
	Current harmonics	OFF		
	Voltage anomalies	OFF		
	Ref. Voltage anomalies	OFF	Single, 4-wire	
		OFF	3-wire, ARON	
Up threshold anomalies	OFF	Each system		
Low threshold anomalies	OFF			
Unbalance		Not available	Single phase	
		OFF	3/4-wire, ARON	

Table 11: Selected parameters of POWER &amp; ENERGY configuration

DEFAULT CONFIGURATION (NPV systems)			
MENU GENERAL	PARAMETER	SETTINGS	
Analyzer Settings	System	4-wire	
	Freq[Hz]	50	
	Clamp Type	FLEX	
	FS Clamp[A]	3000	
	VT Ratio	1	
Analyzer Settings Advanced	Zoom Graphics	AUTO	
	Harm. Type	ALL	
	Harm. Values	ABSOLUTES	
	Zoom 1st Harm.	YES	
	Average Values	NO	
Recording Settings	Comments	DEFAULT	
	Start	Manu	
	Stop	Manu	
	Integration period	15min	
	Cogeneration	OFF	
	General Parameters	V1N,V2N,V3N,VN-PE,V12,V23,V31, I1, I2, I3, IN (only PQA82x), Hz	
		Pt, P1,P2,P3, Qti, Qi1, Qi2, Qi3, Qtc, Qc1, Qc2, Qc3, St, S1, S2, S3, Pft, Pft1, Pft2, Pft3, Cosphi, Cosphi1, Cosphi2, Cosphi3, Eat, Ea1, Ea2, Ea3, Erit, Eri1, Eri2, Eri3, Erct, Erc1, Erc2, Erc3	
	Voltage harmonics	THD, DC, h1, h2, h3...h11	
	Current harmonics	THD, DC, h1, h2, h3...h11	
	Voltage anomalies	ON	
	Ref. Voltage anomalies	230V	
	Up threshold anomalies	+6%	
	Down threshold anomalies	-10%	
	Unbalance	ON	

Table 12: Parameters of default configuration

### CAUTION



The DEFAULT configuration defines the selection of parameters on meter from the factory, as shown in Table 12. Each new modification performed and saved by the user on "Analyser Settings" section replaces this configuration with new selection which can be different from the default standard.

### 5.5. Start a test on PV system

For testing purposes, no setting of the recording parameters is necessary, but only of those relevant to the configuration of the analyzer (see § 5.3.2).

The test can **only** be activated by pressing the **F1** key (RUN) in **GENERAL MENU** → **Real time values** screen. By accessing this screen, the values measured by the instrument will immediately be displayed in real time. If the SOLAR-0x unit is connected too, the temperature and irradiation values, measured by means of the external probes connected to it, will also be available.

Furthermore, the acronym **MPPT** (Multiple Power Point Tracker) shall indicate the characteristic of the DC/AC converter (inverter), capable of maximizing the DC power which can be taken from the photovoltaic field (see the § 10.3 for further details), the acronym **PRp** shall indicated the Performance ratio (evaluated on active powers).

21/10/2011 17:58:16	
<b>PHOTOVOLTAIC - OUTCOME</b>	
PRp = <b>0.680</b>	Pac = <b>3.11 kW</b>
Pdc = <b>4.19 kW</b>	pf = <b>0.98 i</b>
$\eta_{dc}$ = <b>0.91</b>	$\eta_{ac}$ = <b>0.74</b>
Vdc = <b>279.9 V</b>	Vac = <b>250.6 V</b>
Idc = <b>14.97 A</b>	Iac = <b>12.72 A</b>
Irr = <b>818 W/m<sup>2</sup></b>	
Pnom = <b>5.000 kW</b>	
Tpv = <b>14.2 °C</b>	Tenv = <b>17.5 °C</b>

Fig. 100: Examples of screens for recording activation on a PV system

After connecting to the SOLAR-0x or MPP300 (optional) unit and pressing the **F1** key (see the test procedure described in par. 7.1 and 7.3), the instrument will enter the stand-by mode, waiting for recording, and then the recording-in-progress mode. The stand-by and recording-in-progress modes are signalled by certain icons in the display's top part, as shown in the herewith pictures:

21/10/2011 18:06:23	
<b>PHOTOVOLTAIC</b>	
PRp = <b>0.000</b>	Pac = <b>0.00 kW</b>
Pdc = <b>0.00 kW</b>	pf = <b>0.00 i</b>
$\eta_{dc}$ = <b>0.00</b>	$\eta_{ac}$ = <b>0.00</b>
Vdc = <b>0.0 V</b>	Vac = <b>0.0 V</b>
Idc = <b>0.00 A</b>	Iac = <b>0.00 A</b>
Irr = <b>---</b> W/m <sup>2</sup>	
Pnom = <b>5.000 kW</b>	
Tpv = <b>35.0 °C</b>	Tenv = <b>35.0 °C</b>

Fig. 101: Instrument in stand-by mode

21/10/2011 18:07:06	
<b>PHOTOVOLTAIC</b>	
PRp = <b>0.000</b>	Pac = <b>0.00 kW</b>
Pdc = <b>0.00 kW</b>	pf = <b>0.00 i</b>
$\eta_{dc}$ = <b>0.00</b>	$\eta_{ac}$ = <b>0.00</b>
Vdc = <b>0.0 V</b>	Vac = <b>0.0 V</b>
Idc = <b>0.00 A</b>	Iac = <b>0.00 A</b>
Irr = <b>---</b> W/m <sup>2</sup>	
Pnom = <b>5.000 kW</b>	
Tpv = <b>35.0 °C</b>	Tenv = <b>35.0 °C</b>

Fig. 102: Recording in progress



### CAUTION

It is recommended to always start recording by connecting the instrument to the **external supply**, provided with the instrument, in order not to loose any data during the whole measurement campaign.



The instrument can displays messages when pressing the **F1** key:

Message	Description
<i>Before start a test, please check zero reading of DC clamp when it's not connected to the plant</i>	ALWAYS perform at the start of each test the zeroing of the supplied DC clamp connected to the meter <b>and not to the PV installation</b> by pressing ZERO key on it. The result should be a "0.000A" on meter but a small current value up to "0.02A" is permitted. After that, connect the DC clamp to the installation
<i>Fw SOLAR-01 &lt; 2.02 – Irr.min = 600W/m2</i>	The minimum irradiance threshold different from 600W/m <sup>2</sup> and the internal Fw of SOLAR-01 is < 2.02. The Fw update of SOLAR-01 unit require to send the unit to HT service
<i>Fw SOLAR-01 &lt; 2.03 – IP=2min</i>	The IP > 2min and the internal Fw of SOLAR-01 is < 2.03. In this case the recording is aborted as the not updated SOLAR-01 can not saving the values in it's internal memory. The Fw update of SOLAR-01 unit require to send the unit to HT service
<i>No supply</i>	It is recommended to connect the supply provided with the instrument, before starting testing/recording. Anyway, it is also possible to perform a testing/recording without supply, using the instrument's internal battery.
<i>Wrong phase sequence</i>	The value of parameter "SEQ" in section Measure display (see § 5.2.4) is different from "123", which is correct. Check the sequence value of the phases of Voltages V1, V2, V3.
<i>Negative powers</i>	One or more values of the Active Powers P1, P2, P3 are negative (see § 5.2.4). If necessary, turn the clamps under current by 180° on the conductors in order to obtain always positive values (except for cases of co-generation).
<i>Solar 01 connected Solar 02 connected</i>	Confirms the connection between the instrument and SOLAR-0x. This message <b>MUST ALWAYS appear</b> when connecting the instrument and SOLAR-0x using the USB cable. Should this message not appear when connecting, disconnect and connect again the USB cable to the two units.
<i>SOLAR-01 not connected SOLAR-02 not connected</i>	Check the connection of SOLAR-0x to the instrument. The error message is displayed when trying to stop a testing or trying to start/stop recording where item SOLAR-0x is flagged, while no connection to unit SOLAR-0x has been detected.
<i>SOLAR-0x is not recording. Stop recording.</i>	This message warns the user that a SOLAR-0x unit with no active recording has been connected to a instrument unit during the testing/recording phase.
<i>Testing in progress</i>	This message is displayed when a testing is being carried out and the GO/STOP key is pressed. It is not possible to start recording while a test is already being carried out. Stop testing by pressing the F1 key (FINISH).
<i>Do you want to stop recording?</i>	Message which asks the user for confirmation before stopping the recording/test currently being carried out.
<i>Wait for recording start</i>	This message warns the user that the recording/test will start when reaching the following minute or when reaching the date and time set for start (only for recordings on NPV systems).
<i>Wait for data download</i>	This message warns the user of the data transferring phase from unit SOLAR-0x to the instrument. Do not disconnect the USB cable during this phase.
<i>Analysis impossible</i>	This message warns the user that the data recorded are not compatible with the set minimum irradiation threshold (see § 5.3.3.3) and it is not possible to provide any result.
<i>MPP300 connected</i>	This message confirms the connection between the instrument and MPP300. This message <b>MUST ALWAYS</b> be displayed when connecting the master unit to the MPP300 via USB cable. If, upon connection, this message should not appear, disconnect the USB cable and connect it again.
<i>Error in data download from SOLAR-02</i>	A transmission error has occurred between the SOLAR-02 and SOLAR300N or MPP300 units. Switch off and on again all units and connect them again. The units will try data transfer again.
<i>MPP300: low battery</i>	The battery of MPP300 is almost flat. Connect the external power supply to MPP300.
<i>No external power supply for MPP300. Continue?</i>	This message warns that, in order to carry out very long recordings, it is advisable to connect the external power supply to MPP300.
<i>MPP300: exchanged AC and DC voltages</i>	An exchange in the connection between DC and AC voltages has been detected. Check the connections.
<i>MPP300: negative power</i>	One or more Ac negative powers has been measured. This is normally due to a connection error. Check the connections.
<i>SOLAR-02: not detected. Stop recording?</i>	You are trying to stop recording while the SOLAR-02 unit is not connected with the MPP300 unit.
<i>SOLAR-02:Firmware not correct</i>	Firmware of SOLAR-02 dosen't match with SOLAR300N Firmware
<i>MPP300:Firmware not correct</i>	Firmware of MPP300 dosen't match with SOLAR300N Firmware

Table 13: Description of error before starting recording

### 5.5.1. While testing

After starting a test, the instrument allows displaying in real time both the parameters set and the current state of the operation.

1. Use the arrow keys or select the icon "Saved Data Management" in the GENERAL MENU.
2. With a recording in progress, press the **ENTER** key or touch the icon "Saved Data Management" on the display. The instrument displays the following screen:



Fig. 103: Screen with information about recording in progress with PV system set

3. The screen above contains the following information:
  - Recording autonomy of the instrument with selections made in Days/Hours
  - Comments inserted in the relevant comment field of section "Analyzer setting" (see § 5.4.2.1).
  - Type, data and hour when recording started
  - Type of recording stop (always manual)
  - The Integration Period set
  - The number of integration periods made in real time
  - The type of photovoltaic system considered
  - If the parameters of SOLAR-0x (Irradiation, Cell Temperature, Environmental Temperature) are being recorded
  - The type of clamp used
  - The full scale selected for the clamps used
4. Press the **ESC** key (or smart icon ) to exit the information screen.



### CAUTION

- Only section "Measure display" is available while testing. The instrument displays the message "Menu not available while recording" in case of selection of other sections. Stop testing by pressing the **F1** key.
- The **ON/OFF** key is disabled while testing. The instrument shows the message "Recording in progress. Function not available". Stop testing by pressing the **F1** key.



### 5.5.2. Stop a test

To stop a test (after connecting the unit SOLAR-0x or the unit MPP300 to the main unit), press the **F1** key. The icon highlighted in Fig. 102 disappears from the display.

After the automatic data transfer phase, the instrument will automatically display:

➤ The maximum performance outcome (max PRp), according to § 5.3.2.6

or

➤ Will show the message "Results don't comply with minimal test requirements" if the Irradiance values were not steady or never reach minimum Irradiance value.

Press:

**SAVE:** to save the results obtained. Pressing the key will display the virtual keyboard for typing possible comments. A further pressing of the **SAVE** key will store the measure and the typed comments and will go back to the initial screen, ready for a new measurement. The data will be recorded in a RegPV file and you'll have the possibility to view them on the display at all times (see § 5.7.2)

**ESC:** to **delete** the detected data and go back to the initial screen, ready for a new measurement.



## 5.6. START A RECORDING

The meter is designed to start a recording in **MANUAL** or **AUTOMATIC** mode (the Automatic only for NPV systems - see § 5.4.2.3) by pressing of **GO/STOP** key. A recording operation can be started exclusively under the following screens:

- **GENERAL MENU** (with any selected icon)
- **Real time values** (in any internal screen)

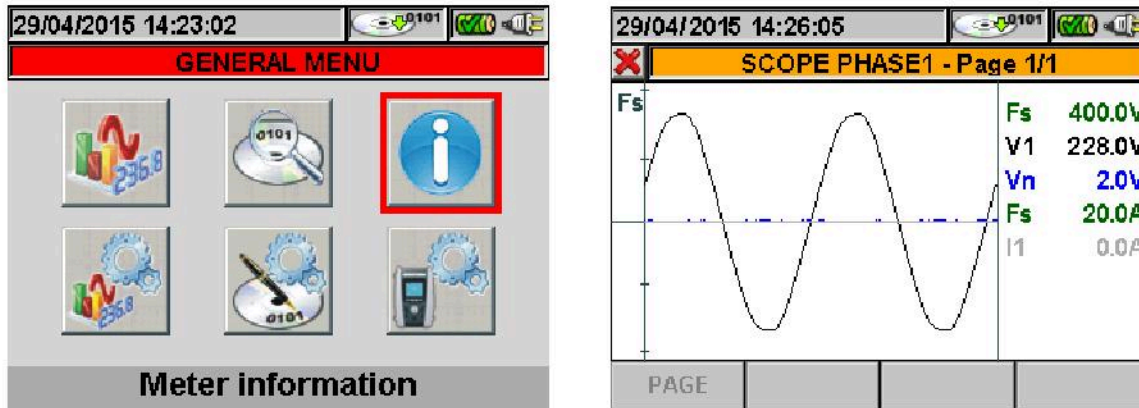



Fig. 104: Example of screens for recording starting

Before starting a recording press **ESC** key (or the smart icon ) until you get a picture as shown in Fig. 104. This operation can be performed in the below ways:

- ✓ **MANUAL:** Recording will start at the following minute after pressing **GO/STOP** key.
- ✓ **AUTO:** Only if the instrument is configured for NPV systems: When pressing the **GO/STOP** key (**necessary**), the instrument remains in stand-by until reaching the date/time set (see § 5.4.2.2) to start recording.

The waiting and recording run status are marked by meter with dedicated icons which are present on the top right of display, as shown in below picture:

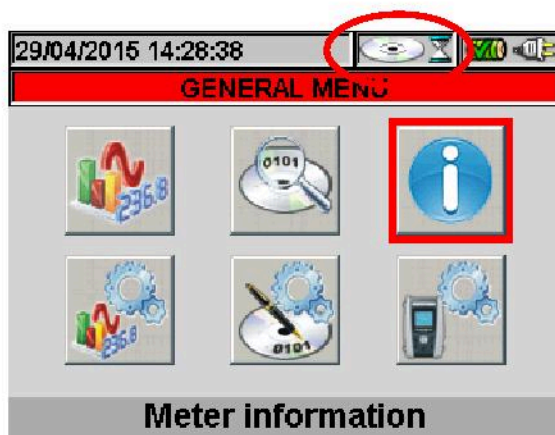

Fig. 105: Meter waiting for recording



Fig. 106: Meter in recording run

Press again **GO/STOP** key to stop the recording run in any time. The icon shown in Fig. 106 disappear.



### CAUTION

For recordings **ALWAYS** use the external power supply even though the instrument allows the operator to perform a recording using internal batteries.

After starting a recording a preliminary real time evaluation about the situation on electrical installation it's important in order to perform a correct settings, using the predefined configurations (see § 5.4.2.14) if necessary.

The below warning message can be shown by meter after pressing of **GO/STOP** key:

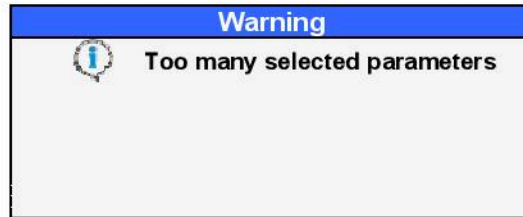

Fig. 107: Warning message of too many selected parameters

In this case of too many parameters were selected it is necessary to disable them inside "Recordings Settings" section in order to start a correct recording.

After pressing **GO/STOP** key a possible warning message window is shown by meter. Inside this window message the internal item can be different as for type and number. This warning message, which does not block the recording start, is important for user to correct possible errors performed during meter's setting:

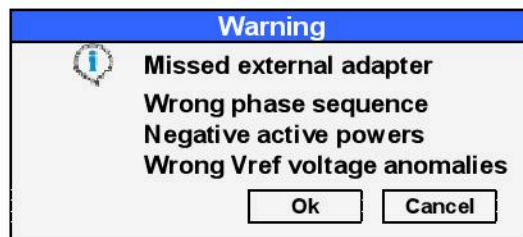

Fig. 108: Warning message errors screen



Below the meaning of the above s of warning windows screen:

Type of error	Description
<i>Before start a test, please check zero reading of DC clamp when it's not connected to the plant</i>	ALWAYS perform at the start of each test the zeroing of the supplied DC clamp connected to the instrument <b>and not to the PV installation</b> by pressing ZERO key on it. The result should be a "0.000A" on meter but a small current value up to "0.02A" is permitted. After that, connect the DC clamp to the installation
<i>Fw SOLAR-01 &lt; 2.02 – Irr.min = 600W/m2</i>	The minimum irradiance threshold is different from 600W/m <sup>2</sup> and the internal Fw of SOLAR-01 is < 2.02. The Fw update of SOLAR-01 unit require to send the unit to HT service
<i>Fw SOLAR-01 &lt; 2.03 – IP=2min</i>	The IP > 2min and the internal Fw of SOLAR-01 is < 2.03. In this case the recording is aborted as the not updated SOLAR-01 can not saving the values in it's internal memory. The Fw update of SOLAR-01 unit require to send the unit to HT service
<i>No supply</i>	It is recommended to connect the supply provided with the instrument, before starting testing/recording. Anyway, it is also possible to perform a testing/recording without supply, using the instrument's internal battery.
<i>Wrong phase sequence</i>	The value of "SEQ" parameter in Real Time Values section (see § 5.2.1) is different from the correct "123". Check the phase sequence value of V1, V2, V3 voltages.
<i>Negative active powers</i>	One or more values of P1, P2, P3 Active Powers is negative (see § 5.2.1). Reversing if necessary the transducer clamps of 180 degrees on phase cables in order to obtain always positive values (except cogeneration cases).
<i>Wrong Vref voltage anomalies</i>	The nominal reference voltage value for voltage anomalies is not compliance to the type of selected system (see § 5.4.2.9).
<i>Solar 01 connected Solar 02 connected</i>	Confirms the connection between the instrument and SOLAR-0x. This message MUST ALWAYS appear when connecting the instrument and SOLAR-0x using the USB cable. Should this message not appear when connecting, disconnect and connect again the USB cable to the two units.
<i>SOLAR-0x not connected</i>	Check the connection of SOLAR-0x to the instrument. The error message is displayed when trying to start/stop a recording where item SOLAR-0x is flagged, while no connection to unit SOLAR-0x has been detected.
<i>Do you want to stop recording?</i>	Message which asks the user for confirmation before stopping the recording currently being carried out.
<i>Wait for recording start</i>	This message warns the user that the recording will start when reaching the following minute or when reaching the date and time set for start (only for recordings on NPV systems).
<i>Analysis impossible</i>	This message warns the user that the data recorded are not compatible with the set minimum irradiation threshold (see § 5.3.3.3) and it is not possible to provide any result
<i>Wait for data download</i>	This message warns the user of the data transferring phase from unit SOLAR-0x to the instrument. Do not disconnect the USB cable during this phase.
<i>MPP300 connected</i>	This message confirms the connection between the instrument and MPP300. This message MUST ALWAYS be displayed when connecting the master unit to the MPP300 via USB cable. If, upon connection, this message should not appear, disconnect the USB cable and connect it again.
<i>Error in data download from SOLAR-02</i>	A transmission error has occurred between the SOLAR-02 and SOLAR300N or MPP300 units. Switch off and on again all units and connect them again. The units will try data transfer again.
<i>MPP300: low battery</i>	The battery of MPP300 is almost flat. Connect the external power supply to MPP300.
<i>No external power supply for MPP300. Continue?</i>	This message warns that, in order to carry out very long recordings, it is advisable to connect the external power supply to MPP300.
<i>MPP300: exchanged AC and DC voltages</i>	An exchange in the connection between DC and AC voltages has been detected. Check the connections.
<i>MPP300: negative power</i>	One or more Ac negative powers has been measured. This is normally due to a connection error. Check the connections.
<i>SOLAR-02: not detected. Stop recording?</i>	You are trying to stop recording while the SOLAR-02 unit is not connected with the MPP300 unit.
<i>SOLAR-02:Firmware not correct</i>	Firmware of SOLAR-02 dosen't match with SOLAR300N Firmware
<i>MPP300:Firmware not correct</i>	Firmware of MPP300 dosen't match with SOLAR300N Firmware

Table 14: Description of errors before start a recording

Depending on the type and number of errors, the necessary modifications of setting parameters should be performed.



Press **GO/STOP** key again to start recording and verify the possible residual error on window message.

Confirm with **ENTER** or press “Ok” or “Cancel” keys to close the warning window message and start the recording by pressing **GO/STOP** key anyway.

As the default value of the integration periods is set at **15min** (see § 10.11.1) the meter will store data in the temporary memory for this time. Afterwards the meter will process the results saved in the temporary memory and will save the first series of values in the definitive memory. Therefore, if an integration period of 15 minutes has been set, the recording will continue for about 15 minutes before producing a series of recorded values



### CAUTION

Let the meter record for **at least** one integration period in order to save a valid value. If the recording is interrupted before the selected integration period has completely elapsed the data stored in the temporary memory will not be processed and the corresponding series of values won't be transferred to the definitive memory.

#### 5.6.1. Recording settings screen – NPV systems (only for NPV systems)

To start a recording under automatic mode a preliminary definition of a correct starting Date/Hour, compatible with system date, is needed inside “Recorder Settings” section (see § 5.4). The below screen is shown:

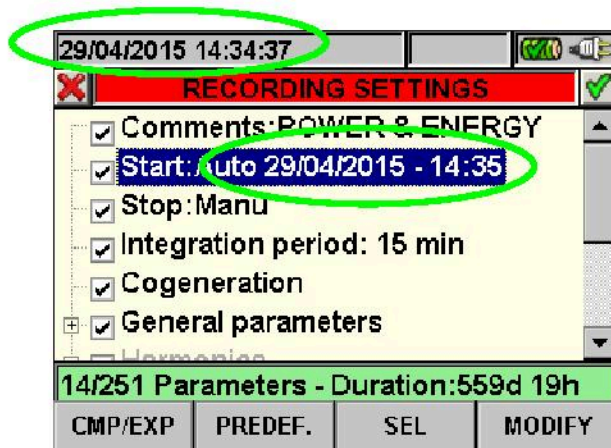



Fig. 109: Correct Date/Hour



Fig. 110: Wrong Date/Hour

1. Move the cursor using arrows keys on field relative to “Start” (and or the “Stop” ), marked them with blue background
2. Press **F4** key (alternatively touch the **MODIFY** at display). In the bottom of display a command bar with “Manu” is shown. Press **F3** key (**MOD(+)**) or **F4**(**MOD(-)**) and select “Auto”
3. Use left or right arrows keys to move on date and hour fields. Using the up arrow key or **F3 (MOD(+))** key to increase the value and the down arrow key or **F4 (MOD(-))** key to decrease the value. Set a correct Date/Hour as shown in Fig. 109
4. Press **SAVE** or **ENTER** keys (or smart icon ) to saving the settings. The screen of Fig. 110
5. is shown if a wrong Date/Hour is set. Under this condition the **SAVE** key does not have any effect. Repeat the steps 2 and 3 and set corrects values before pressing **SAVE** key again

### 5.6.2. During a recording

After a recording is running, a real time check of parameters's values and internal status is shown by meter.



Fig. 111: Recording Results screen - Recording running

1. Select "Recording Results" in GENERAL MENU
2. Pressing **ENTER** or touch the correspondent icon at display.

The below screen is shown (with NPV system set):



Fig. 112: Info recording running screen

3. The below information are included in the above screen:
  - Recording autonomy, in Days/Hours, of meter with the currents selections performed.
  - Comments included in the relative section (see § 5.4.2.1).
  - Type, date and time of recording start
  - Type of recording stop
  - The Integration Period set
  - Real time information about integration period performed by meter
  - Enable of cogeneration
  - Number of recorded voltage anomalies
  - Type of selected system
  - Type of used clamp
  - Full scale of used clamp
  - Ratio of eventual external PT used



The instrument displays the following screen (with PV system set):

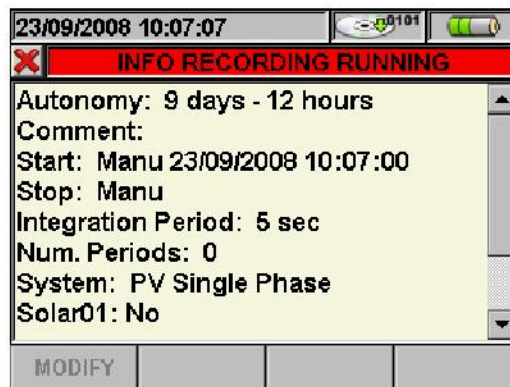

Fig. 113: Screen with information about recording in progress with PV system set

4. The screen shown in Fig. 113 contains the following information:

- Recording autonomy of the instrument with selections made in Days/Hours
- Comments inserted in the relevant comment field of section “Analyzer setting” (see § 5.4.2.1).
- Type, data and hour when recording started
- Type of recording stop
- The Integration Period set
- The number of integration periods made in real time
- The type of photovoltaic system considered
- If the parameters of SOLAR-0x (Irradiation, Cell Temperature, Environmental Temperature) are being recorded
- The type of clamp used
- The full scale selected for the clamps used

5. Pressing **ESC** key (or the smart icon ) to quit from the above screen.

Each recording running is stopped and results are **automatically** saved by meter by pressing of **GO/STOP** key or as soon as the date/hour of automatic stop is reached. The data will be recorded in a Reg file (NPV systems) or RegPV (for PV systems) and you'll have the possibility to view them on the display at all times (see par. 5.7.2)



### CAUTION

- The only “Real Time Values” section is available during a recording running. The message “*Menu not available in recording*” is shown by meter if any section is selected. Stop recording pressing **GO/STOP** key before select any section.
- **ON/OFF** key is disabled during a recording running. The message “*Recording running. Not available function*” is shown by meter. Stop recording pressing **GO/STOP** key before pressing this key.



## 5.7. SAVED DATA MANAGEMENT SECTION

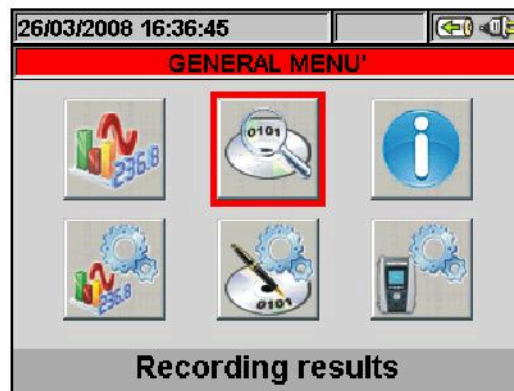

Fig. 114: GENERAL MENU - Saved Data Management

The “Saved Data Management” section allows the user to check the content of the internal memory after recording, to delete previous recordings and possibly to copy a recording (one at a time) on an external USB Pen Driver connected to the instrument. By pressing the **ENTER** key or selecting the icon on the display, the instrument shows the following screen:

N.	Type	Time 1	Time 2
5	RegPV	09/09/2008	09/09/2008
6	Rec	18/09/2008	18/09/2008
7	RegPV*	22/09/2008	22/09/2008
8	RegPV*	22/09/2008	22/09/2008
9	Snapshot	22/09/2008	10:24:46
10	RegPV*	23/09/2008	23/09/2008

Fig. 115: Saved data

The instrument performs the following types of recordings:

- **Reg** type: recordings performed and saved **automatically**, both in manual and automatic mode, of each analysis (Periodics, Harmonics, Voltage Anomalies, Flickers, etc...) by pressing the **GO/STOP** key.
- **Istant** type: instant samplings of the values displayed (numerical, waveforms, harmonics, PV tests, etc.) performed by pressing the **SAVE** key
- **RegPV** type: recordings performed on photovoltaic systems and saved by pressing the **GO/STOP** key or tests of photovoltaic system saved by pressing the **SAVE** key.
- **RegPV\*** type: type of data similar to RegPV, but for which the data transferring phase between SOLAR-0x and the instrument has not been completed. For this type of recordings NO result will be available.
- **RegMPP** type: recordings/tests of PV systems carried out by means of MPP300 and **automatically** saved for each analysis on a photovoltaic system by pressing the **GO/STOP** key and at the end of a photovoltaic system test by pressing the **SAVE** key.

Each line of the “Saved Data Management” screen includes, further to the type of data saved in the memory, also the information on the starting and stopping date of the event, respectively “Time1” and “Time2” for **Reg** and **RegFV** type recordings, while date and time are indicated for **Istant** instant sampling.

The following operations are possible only on the screen in Fig. 115:

1. Use the up and down arrow keys to highlight (blue background) one of the recordings on the screen. Press the **F1** key (or the **INFO** item on the display). The instrument shows the screen containing the main information regarding the recording performed as described in § 5.7.1.
2. Press the **F3** key (or the **DEL** item on the display) to delete the **last saved recording**. The instrument shows the message “Delete last recording?”. Confirm the operation with “Ok” or “Cancel” to go back to the screen.
3. Press the **F4** key (or the **DEL ALL** item on the display) to delete **all recordings in the memory**. The instrument shows the message “Delete all recordings?”. Confirm the operation with “Ok” or “Cancel” to go back to the previous screen.

### 5.7.1. Recording analysis (Reg type)

This page shows the analyses which can be performed on the saved data (Reg type).

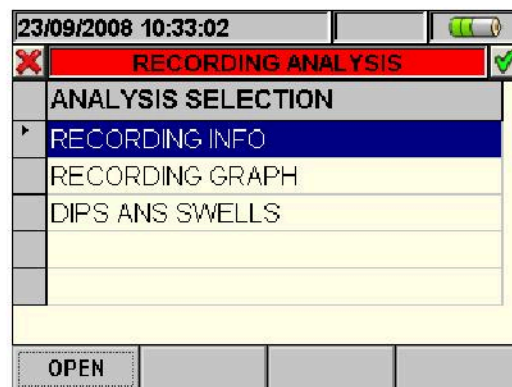



Fig. 116: Recording analysis (Reg-type data)

1. Use the up and down arrow keys to highlight on blue background one of the analyses on the screen. Press the **F1** or **ENTER** key (or the **OPEN** item or the smart icon  on the display) to confirm the type of analysis to be performed.
2. Press the **ESC** key (or the smart icon ) to exit the function and go back to the “Saved data” page (Fig. 115).

#### 5.7.1.1. Recording information

This page contains general information about the recording (Reg) file previously selected in the Saved Data Management MENU.

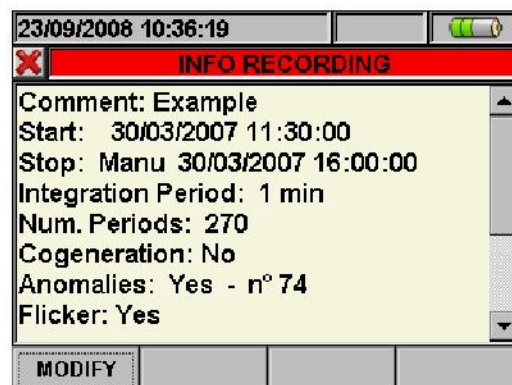



Fig. 117: Recording info

1. In these conditions, the **F1** key (or the **MODIFY** key on the display) is active and it is possible to modify and save the comment line by using the virtual keyboard (see § 5.4.2.2).
2. Press the **ESC** key (or the smart icon ) to exit the function and go back to the “Recording analysis” page (Fig. 116).



### 5.7.1.2. Recording graph

By selecting the recording graph option, the following page is accessed, which enables the user to display the recording trend (ONLY ONE parameter at a time).

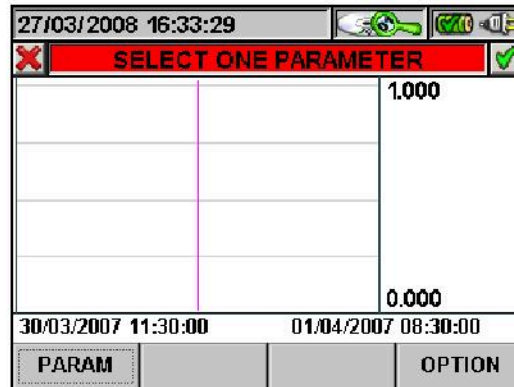

Fig. 118: Selecting a parameter

1. Press the **F1** key (or the **PARAM** item on the display) to access the page containing the recorded quantities available for the analysis (Fig. 119).

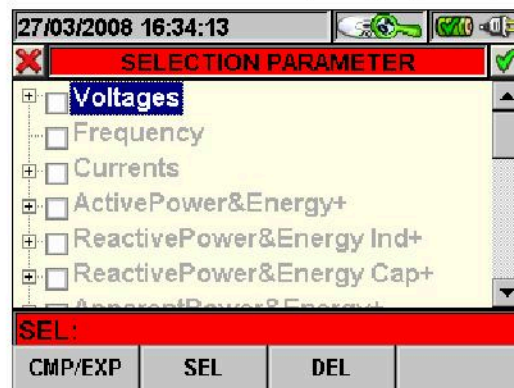



Fig. 119: Parameter selection

The following keys are active on this page:

- The up and down arrow keys move the cursor along the quantity tree.
- The **F1** key (or the **CMP/EXP** item on the display) compresses and expands the tree of the quantity highlighted by the cursor.
- The **F2** key (or the **SEL** item on the display) selects or deselects the parameter highlighted by the cursor.
- The **ENTER** key (or the smart icon ) confirms the selection previously made and displays the graph of the selected parameter (Fig. 120).
- The **CANC** key deselects the parameter previously selected, independently from the position of the cursor.
- The **ESC** key (or smart icon ) to exit the function and go back to the "Selecting a parameter" page (Fig. 118).



This page shows the graph, the cursor position (cursor T) and the maximum, minimum and average RMS values of the parameter selected by the cursor.



Fig. 120: Recording graph

The following keys are active on this page:

- **F1** key (or **PARAM** item on the display) to access the page of the selectable parameters (Fig. 119).
  - **F4** key (or **OPTIONS** item on the display) to access the page for the activation of the "Advanced graph" (Fig. 121).
  - The **ESC** key (or smart icon ) to exit the function and go back to the "Recording analysis" page (Fig. 116).
2. Press the **F4** key (or the **OPTIONS** item on the display) to access the page for the activation of the Advanced graph (Fig. 121).

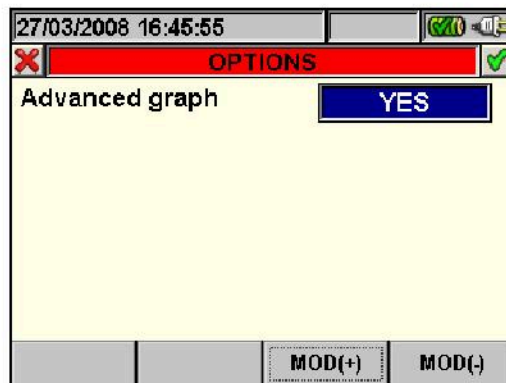





Fig. 121: Options (Advanced graph)

The following keys are active on this page:

- The **F3** and **F4** keys (or the **MOD(+)** and **MOD(-)** items on the display) enable the user to choose **YES** or **NO** for the advanced graph.
- The **ENTER** key (or the smart icon ) confirms the selection previously made.
- The **ESC** key (or smart icon ) to exit the function and go back to the "Selecting a parameter" page (Fig. 118).

#### Example of advanced graph.

Let us take a recording of 2000 pixels into consideration. The SOLAR300N has a display with a useful resolution of about 200 pixels; therefore, it is not able to distinctly display all the pixels in our recording. How does it operate then? The first pixel in the graphs of the curves "Max value", "Average value" and "Min value" will be the analysis of the 10 first corresponding pixels of the recording, similarly, the second pixel will be the analysis of the following 10 pixels, and so on until the whole graph is generated.

3. Press the **ESC** key (or the smart icon ) to exit the function and go back to the "Selecting a parameter" page (Fig. 118).

### 5.7.1.3. Dips ans swells

This page shows a table containing all voltage anomalies occurred during recording.



N.	L	Time	Max/Min
1	3	30/03/07 11:30:24:44	180.2
2	3	30/03/07 11:32:10:18	175.3
3	3	30/03/07 11:32:38:23	178.5
4	3	30/03/07 11:32:43:30	183.8
5	1	30/03/07 11:41:01:25	262.7
6	3	30/03/07 11:41:01:27	185.4

Fig. 122: Dips ans swells

Column description:

- N.:** progressive number of the anomaly.  
**L.:** phase in which the anomaly occurred.  
**Date/Time:** date/time at which the anomaly occurred.  
**Max/Min:** maximum/minimum value of the anomaly.  
**Duration:** duration of the anomaly.  
**Type:** type of anomaly (voltage reduction or overvoltage).

The following keys are active on this page:

- The up and down arrow keys move the cursor along the voltage anomalies.
- The up and down arrow keys move the column display to the right or to the left.
- The **F1** key (or the **PAG** item on the display) advances to the following page of voltage anomalies (to be selected with the **F3** or **F4** key or through the items **MOD (+)** or **MOD (-)** on the display).
- The **F2** key (or the **PARAM** item on the display) accesses the page showing the settings for voltage anomalies (Fig. 123).
- The **ESC** key (or smart icon ) to exit the function and go back to the "Recording analysis" page (Fig. 116).

This page shows the parameters set before recording voltage anomalies:

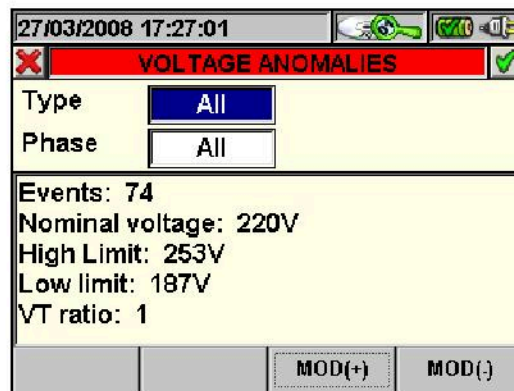

Fig. 123: Voltage Anomalies

The following non-modifiable parameters are indicated (as they have been set upon starting the recording)

**Nominal Voltage:** nominal voltage



**High Voltage:** limit high voltage.

**Low Voltage:** limit low voltage.

**VT:** transformation ratio of the voltage transformers.

This page also shows the total number of voltage anomalies occurred (**Number of Anomalies**).

The following keys are active on this page:

- The up and down arrow keys move the cursor alternatively on **Type** or **Phase**
- The **F3** and **F4** keys (or the **MOD(+)** and **MOD(-)** items on the display) enable the user to filter the anomalies to be selected. It is possible to select **All**, **Up**, **Down**, **Int** (if the cursor highlights **Type**) and **All**, **Phase1**, **Phase2**, **Phase3** (if the cursor highlights **Phase**)
- The **ENTER** key (or the smart icon ) confirms the selection previously made and displays the table of voltage anomalies.
- The **ESC** key (or the smart icon ) to exit the functions and go back to the "Anomalies" page (Fig. 122).

#### 5.7.1.4. Spikes (Transients)

This page shows a table containing all of the Spikes, i.e. all of the phenomena associated to phase voltage characterized by:

- Fast variations of voltage waveform slope
- Exceedings of a limit threshold defined by the user before recording

N.	L	Time	Peak+
1	1	30/03/07 11:43:00:62	485.3
2	1	30/03/07 11:43:00:74	501.9
3	1	30/03/07 11:43:00:88	505.2
4	1	30/03/07 11:43:01:10	41.6
5	3	30/03/07 11:43:01:76	0.0
6	3	30/03/07 11:43:01:76	40.9

Fig. 124: Spikes



Description of the columns:

- N.:** Progressive spike number.
- L.:** Phase in which the spike occurred.
- Time:** Date/time in which the anomaly occurred.
- Peak+:** Max. positive value reached by the spike during the observation interval.
- Peak-:** Min. negative value reached by the spike during the observation interval.
- Delta+:** Max. relative positive differential reached by the spike during the observation interval.
- Delta-:** Min. relative negative differential reached by the spike during the observation interval.
- Type:** Spike type (Up/Down).
- F/S:** Spike speed (Fast if  $dV/dt > 100V/5\mu s$ , Slow if  $dV/dt > 100V/78\mu s$ ).

Within this page, the following keys are active:

- The up and down arrow keys move the cursor along the list of Spikes
- The right and left arrow keys move the column display to the right or to the left
- The **F1** key (or the **PAG** item on the display) moves to the following pages of Spikes (to be selected with the **F3** or **F4** key or with the **MOD (+)** or **MOD (-)** items on the display)
- The **F2** key (or the **PARAM** item on the display) accesses the page which shows the settings made for the Spikes (see Fig. 125)
- The **ESC** key (or the smart icon ) exits the function and goes back to the "Recording Analysis" page (see Fig. 116)

This page shows the parameters set for voltage Spikes before recording:

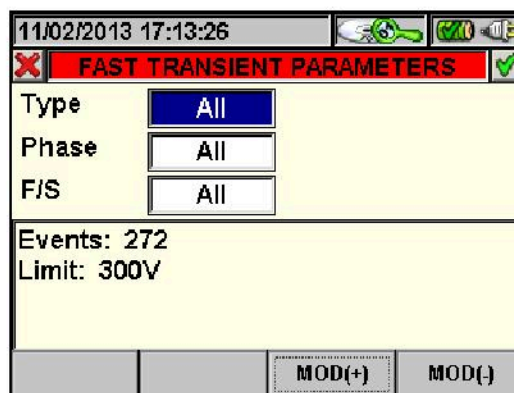



Fig. 125: Spikes parameters

The following elements are indicated:

**Limit:** set voltage threshold.

The total number of spikes occurred is also displayed (**Events**)

Within this page, the following keys are active:

- The up and down arrow keys move the cursor alternately onto **Type**, **Phase** or **F/S**
- The **F3** and **F4** keys (or the item **MOD (+)** and **MOD (-)** on the display) allow filtering the Spikes to be selected. It is possible to select **All**, **Up**, **Down** (if the cursor highlights **Type**); **All**, **Phase1**, **Phase2**, **Phase3**, **Neutral** (if the cursor highlights **Phase**); **All**, **Fast**, **Slow** (if the cursor highlights **F/S**)
- The **ENTER** key (or the smart icon  on the display) confirms the choice previously made and displays the Voltage Spike table
- The **ESC** key (or the smart icon ) exits the function and goes back to the "Spikes" page (see Fig. 124)

### 5.7.1.5. Inrush currents

This page shows a table containing all of the Inrush current occurred while recording

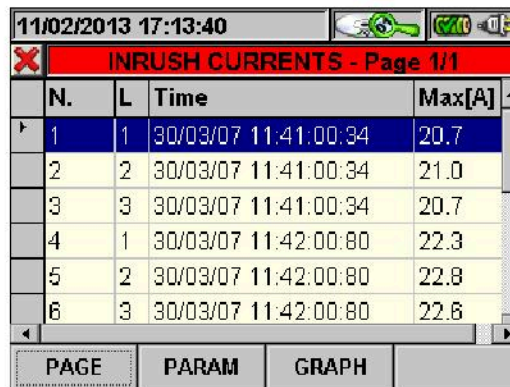

N.	L	Time	Max[A]
1	1	30/03/07 11:41:00:34	20.7
2	2	30/03/07 11:41:00:34	21.0
3	3	30/03/07 11:41:00:34	20.7
4	1	30/03/07 11:42:00:80	22.3
5	2	30/03/07 11:42:00:80	22.8
6	3	30/03/07 11:42:00:80	22.6

Fig. 126: Inrush currents

Description of the columns:

<b>N.:</b>	Progressive number of inrush current.
<b>L.:</b>	Phase in which inrush current has occurred.
<b>Time:</b>	Date/time in which the inrush current occurred.
<b>Max[A]:</b>	Maximum value reached by the inrush current.

Within this page, the following keys are active:

- The up and down arrow keys move the cursor along the list of events
- The right and left arrow keys move the column display to the right or to the left
- The **F1** key (or the **PAG** item on the display) moves to the following pages of Inrush Currents (to be selected with the **F3** or **F4** key or with the **MOD (+)** or **MOD (-)** items on the display)
- The **F2** key (or the **PARAM** item on the display) accesses the page which shows the settings made for the Inrush Currents (see Fig. 127)
- The **F3** key (or the **GRAPH** item on the display) accesses the page which shows the graph of the selected Inrush Current (see Fig. 128)
- The **ESC** key (or the smart icon ) exits the function and goes back to the "Recording Analysis" page (see Fig. 116)

This page shows the parameters set for Inrush Currents before recording:

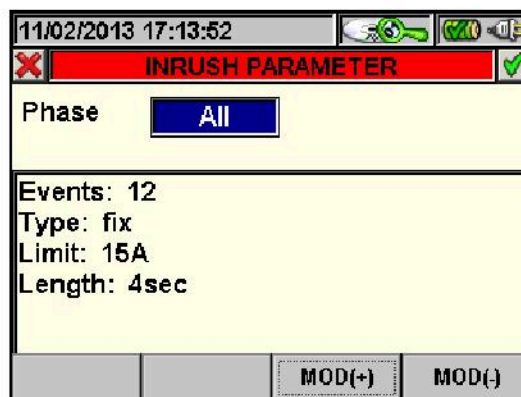

11/02/2013 17:13:52

**INRUSH PARAMETER**

Phase **All**

Events: 12  
 Type: fix  
 Limit: 15A  
 Length: 4sec

MOD(+) MOD(-)

Fig. 127: Inrush currents parameters



The following elements are indicated:

**Type:** Set detection type:

**Fix:** The instrument detects and saves an event when the current's RMS value calculated in each half-period exceeds the value of the threshold defined by the user. **In order for the instrument to be ready to detect a new event, current must drop below the defined threshold value;**



**Var:** The instrument detects and saves an event each time the current's RMS value calculated in each half-period exceeds the previous RMS value (i.e. the RMS value calculated in the previous half-period) by a quantity equal to the threshold defined by the user.

**Limit:** Set current threshold.

**Duration:** Set observation interval.

The total number of Inrush Currents occurred is also displayed (**Events**)

Within this page, the following keys are active:

- The **F3** and **F4** keys (or the item **MOD (+)** and **MOD (-)** on the display) allow filtering the Inrush Currents to be selected. It is possible to select **All**, **Phase1**, **Phase2**, **Phase3**, **Neutral**
- The **ENTER** key (or the smart icon  on the display) confirms the choice previously made and displays the Inrush Current table
- The **ESC** key (or the smart icon ) exits the function and goes back to the "Inrush Currents" page (see Fig. 126)

This page shows the graph, the position of the cursor, the maximum/minimum current and voltage values, the current and voltage value relevant to the position of the cursor of the selected Inrush Current



Fig. 128: Inrush currents graph

Within this page, the following keys are active:

- The **F1** key (or the **SEL V,I** item on the display) shows the graph relevant to Voltage and Current
- The **F2** key (or the **SEL V** item on the display) shows the graph relevant to Voltage
- The **F3** key (or the **SEL I** item on the display) shows the graph relevant to Current
- The right and left arrow keys move the cursor to the right or to the left along the graph
- The **ESC** key (or the smart icon ) exits the function and goes back to the "Inrush Currents" page (see Fig. 126)



### 5.7.1.6. EN50160

This page shows a table containing values complying with standard EN50160.

Param.	OK	p%@Lim	Min	Max
Hz 99.5%	OK	100.00	49.90	50.10
Hz 100%	OK	100.00	49.90	50.10
V1 95%	OK	100.00	219.80	240.6
V2 95%	OK	100.00	199.90	221.5
V3 95%	NO	82.96	173.20	204.3
V1 100%	OK	100.00	219.80	240.6

Fig. 129: EN50160 analysis result

Description of the columns:

- Param:** It indicates the percentage of the values which must fall within the limits set in **Limits**. Example: **Hz 100%** means that 100% of the frequency values recorded must fall within a 1%, -1% range of the nominal frequency value.
- OK:** **YES** indicates that the analysis has had a positive result, **NO** indicates that the analysis has had a negative result.
- p% @Lim:** Percentage of the measured values which falls within the limits set.
- Min:** Minimum measured value.
- Max:** Maximum measured value.
- Limits:** Set reference limits.

Within this page, the following keys are active:

- The up and down arrow keys move the cursor along the different quantities
- The right and left arrow keys move the column display to the right or to the left
- The **F1** key (or the **PARAM** item on the display) accesses the page which shows the settings made (see Fig. 130)
- The **F2** key (or the **GRAPH** item on the display) accesses the page which shows the histogram of the quantities in the table (see Fig. 131)
- The **ESC** key (or the smart icon ) exits the function and goes back to the "Recording Analysis" page (see Fig. 116)

This page contains the global result of the EN50160 analysis, the system connection condition and the parameters set before recording

11/02/2013 17:14:39			
<b>EN50160 OUTCOME: NO</b>			
Interconnected System		<b>YES</b>	
Events: 74			
Nominal voltage: 220V			
High Limit: 253V			
Low limit: 187V			
Frequency: 50Hz			
		MOD(+)	MOD(-)



Fig. 130: Parameters set for EN50160 analysis

The following elements are indicated:

**Nominal Voltage:** Set nominal voltage  
**High Limit:** Upper limit voltage  
**Low Limit:** Lower limit voltage  
**Frequency:** System frequency.

The total number of Voltage Anomalies occurred is also displayed (**Events**)

Within this page, the following keys are active:

- The **F3** and **F4** keys (or the item **MOD (+)** and **MOD (-)** on the display) allow choosing **YES** or **NO** for an Interconnected System
- The **ENTER** key (or the smart icon ) confirms the choice previously made and displays the table of the values complying with standard EN50160
- The **ESC** key (or the smart icon ) exits the function and goes back to the “EN50160 analysis result” page (see Fig. 129)

This page shows:

- The global result of the analysis, highlighted in red, in case it is **Not Ok** and highlighted in green if it is **Ok**
- Quantity histogram. The green bar indicates that the parameter complies with standard EN50160, while the red bar indicates that the parameter does not respect the standard

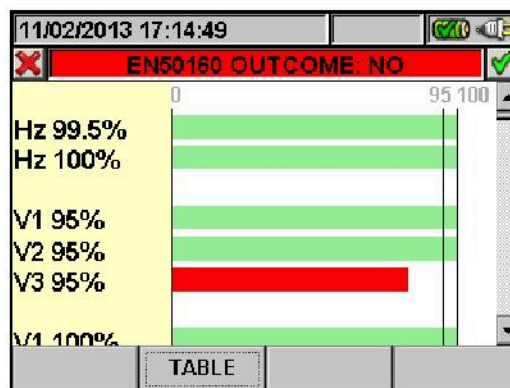



Fig. 131: EN50160 analysis histogram

Within this page, the following keys are active:

- The up and down arrow keys move the vertical bar up and down, thus allowing the display of the histogram of the quantities in the Analysis EN50160
- The **ESC** key (or the smart icon ) exits the function and goes back to the “EN50160 analysis result” page (see Fig. 129)

### 5.7.1.7. Analysis of consumed energy

This page shows the Energy and Peak power values consumed while recording

07/05/2015 11:26:11			
<b>X TOT. ENERGY CONSUMPTION - Pag 7/9</b>			
Eact	=	<b>583 Wh</b>	
Ppeak	=	<b>21.80 kW</b>	
Date Ppeak	:	<b>07/05/15 11:24:20</b>	
Start rec.	:	<b>07/05/15 11:22:00</b>	
Stop rec.	:	<b>07/05/15 11:25:35</b>	
Rec. Time	:	<b>00d 00h 03m</b>	
Int. Per.	:	<b>1 min</b>	Rec. : 10
PAGE	SCOPE	HARM	VECTORS

Fig. 132: Screen of total consumed energy

Description of the displayed values:

- Eact:** Total active power consumed while Recording.
- Ppeak:** Max. active power peak (measured on 16 periods of mains frequency) consumed while recording
- Date Ppeak:** Date and time in which the power peak occurred
- Start rec.:** Starting date of the recording
- Stop rec.:** Stopping date of the recording
- Rec. Time** Recording time expressed in days (d), hours (h) and minutes (m)
- Int. Per:** Set integration period value

### CAUTION



The Total Consumed Energy page is shown only if general parameter Total "Active Power & Energy" has been recorded (see § 5.4.2.7).



### 5.7.1.8. Analysis of produced energy

This page shows the Energy and Peak power values produced while recording

07/05/2015 11:26:17			
<b>TOT. ENERGY PRODUCTION - Pag 9/9</b>			
Eact	=	<b>15 Wh</b>	
Ppeak	=	<b>1.31 kW</b>	
Date Ppeak	:	<b>07/05/15 11:24:20</b>	
Start rec.	:	<b>07/05/15 11:22:00</b>	
Stop rec.	:	<b>07/05/15 11:25:35</b>	
Rec. Time	:	<b>00d 00h 03m</b>	
Int. Per.	:	<b>1 min</b>	Rec. : 10
PAGE	SCOPE	HARM	VECTORS

Fig. 133: Screen of total produced energy

Description of the displayed values:

- Eact:** Total active power produced while Recording.
- Ppeak:** Max. active power peak (measured on 16 periods of mains frequency) produced while recording
- Date Ppeak:** Date and time in which the power peak occurred
- Start rec.:** Starting date of the recording
- Stop rec.:** Stopping date of the recording
- Rec. Time** Recording time expressed in days (d), hours (h) and minutes (m)
- Int. Per.:** Set integration period value

### CAUTION



The Total Produced Energy page is shown only if general parameter Total "Active Power & Energy" has been recorded (see § 5.4.2.7) and if the recording parameter "Co-generation" has been enabled (see § 5.4.2.5).

### 5.7.2. Recording analysis (RegPV type)

This page shows the analyses which can be performed on the saved data (RegPV type).

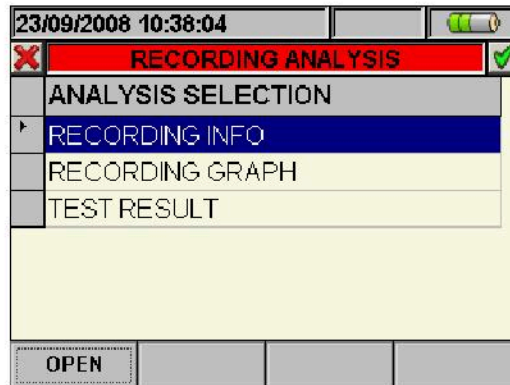



Fig. 134: Recording analysis (RegPV\*-type data)

1. Use the arrow keys up or down to select the one of the available analysys on the screen. Pres **F1** or **ENTER** key (or the item **OPEN** with the smart icon  at display) to confirm the choice
2. The **ESC** key (or smart icon ) to exit the function and go back to the "Recording analysis" page (Fig. 115)

#### 5.7.2.1. Recording information

This page contains general information about the recording (RecPV) file previously selected in the Saved Data Management MENU.

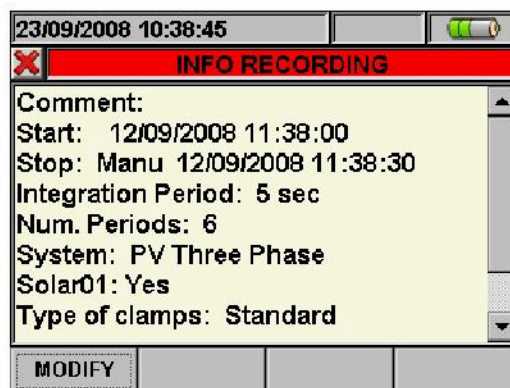



Fig. 135: Recording info

1. In these conditions, the **F1** key (or the **MODIFY** key on the display) is active and it is possible to modify and save the comment line by using the virtual keyboard (see § 5.4.2.2).
2. Press the **ESC** key (or the smart icon  on the display) to exit the function and go back to the "Recording analysis" page (Fig. 134).

### 5.7.2.2. Result for data of RecPV type

This page (not available for RecPV\* data as these recordings are, in fact, incomplete) displays the values of the parameters measured and calculated during the testing / recording phase. In particular, the instrument:

- Do not show any results if do not exist on the PV installation a “**stable irradiance**” condition more than the minimum irradiance threshold (see § 5.3.3.3)
- Display the best performance values if during the recording, the Irradiance values reached the “**stable**” condition and its values were higher than the minimum irradiance threshold (see § 5.3.3.3)



### CAUTION

The instrument acknowledge the “**stable irradiance**” condition for a detected point of measure when, with MEDIUM value of irradiance measured by the pyranometer > set minimum irradiance threshold (see § 5.3.3.3), **the difference between Maximum and Minimum values of irradiance in the same point is < 20W/m<sup>2</sup> (with IP ≤ 1min)**

If more points satisfied the a.m. conditions, the meter consider the point correspondent to a maximum efficiencies combination

The instrument displays the following parameters:

21/10/2011 18:28:14		
<b>PHOTOVOLTAIC - OUTCOME</b>		
DC →	PRp = <b>0.680</b> Pac = <b>3.11 kW</b> Pdc = <b>4.19 kW</b> pf = <b>0.98 i</b> η <sub>dc</sub> = <b>0.91</b> η <sub>ac</sub> = <b>0.74</b> V <sub>dc</sub> = <b>279.9 V</b> V <sub>ac</sub> = <b>250.6 V</b> I <sub>dc</sub> = <b>14.97 A</b> I <sub>ac</sub> = <b>12.72 A</b>	← AC
FV →	Irr = <b>818 W/m<sup>2</sup></b> P <sub>nom</sub> = <b>5.000 kW</b> T <sub>pv</sub> = <b>14.2 °C</b> T <sub>env</sub> = <b>17.5 °C</b>	

#### Legend of parameters for single-phase PV systems:

- PRp → Performance Ratio (active power)
- Pdc → DC power at inverter input
- η<sub>DC</sub> → Photovoltaic panel performance
- V<sub>dc</sub> → DC voltage at inverter input
- I<sub>dc</sub> → DC current at inverter input
- P<sub>ac</sub> → AC power at inverter output
- P<sub>f</sub> → Power factor at inverter output
- η<sub>AC</sub> → Inverter performance
- V<sub>ac</sub> → AC voltage at inverter output
- I<sub>ac</sub> → AC current at inverter output
- I<sub>rr</sub> → Solar irradiation
- P<sub>nom</sub> → Nominal power of the photovoltaic system
- T<sub>pv</sub> → Temperature of photovoltaic panels
- T<sub>env</sub> → Environmental temperature

**The display of the T<sub>env</sub> or T<sub>pv</sub> values in blue indicates that the mentioned values are the default ones, as the ones measured by SOLAR-0x are not available (see § 5.3.2.4).**

Fig. 136: Page of a PV-1 system



21/10/2011 18:28:14		PHOTOVOLTAIC - OUTCOME	
DC →	PRp = 0.83	Pac = 0.665 kW	
	Pdc = 0.734 kW	pf = 0.90 i	
	$\eta_{DC}$ = 0.91	$\eta_{AC}$ = 0.91	
	Vdc = 265.0 V	Vac1 = 363.8 V	
	Idc = 2.771 A	Iac1 = 1.630 A	
FV →	Irr = 852 W/m <sup>2</sup>	Vac2 = 322.5 V	
	Pnom = 0.950 kW	Iac2 = 1.494 A	
	Tpv = 42 °C	Vac3 = 363.1 V	
	Tenv = 26 °C	Iac3 = 1.561 A	

Legend of parameters for three-phase PV systems:

Pdc	→ DC power at inverter input
$\eta_{DC}$	→ Photovoltaic panel performance
Vdc	→ DC voltage at inverter input
Idc	→ DC current at inverter input
Pac	→ AC power at inverter output
Pf	→ Three-phase power factor at inverter output
$\eta_{AC}$	→ Three-phase inverter performance
Vac1,2,3	→ AC voltage at inverter output
Iac1,2,3	→ AC current at inverter output
Irr	→ Solar irradiation
Pnom	→ Nominal power of the photovoltaic system
Tpv	→ Temperature of photovoltaic panels
Tenv	→ Environmental temperature

The display of the Tenv or Tpv values in blue indicates that the mentioned values are the default ones, as the ones measured by SOLAR-0x are not available (see § 5.3.2.4).

Fig. 137: Page of a PV-3 system

Press the **ESC** key (or the smart icon on the display) to exit the function and go back to the "Recording analysis" page (Fig. 134).

### 5.7.2.3. Result for data of RecMPP type

This page shows the values of the parameters measured and calculated during the test / recording phase together with the MPP300 unit (optional).

In particular, the instrument:

- Do not show any results if do not exist on the PV installation a “**stable irradiance**” condition more than the minimum irradiance threshold (see § 5.3.3.3)
- Display the best performance values if during the recording, the Irradiance values reached the “**stable**” condition and its values were higher than the minimum irradiance threshold (see § 5.3.3.3)

### CAUTION



The instrument recognizes the condition of “**steady irradiation**” for a detected measuring point when, with AVERAGE irradiation value measured by the pyranometer  $>$  minimum threshold set (see § 5.3.3.3), **the difference between the maximum and minimum irradiation values measured is  $<$   $20\text{W/m}^2$  (with  $\text{IP} \leq 1\text{min}$ )**

If there are more points satisfying the above-mentioned condition, the instrument considers the one in which the combination of the performance values takes the maximum value.

24/10/2011 11:34:22		← 0 →	
✘ PHOTOVOLTAIC - OUTCOME			
PRp =	0.800	Pac =	3.71 kW
Pdc =	3.98 kW	ηac =	0.93
ηdc =	0.86		
Irr =	959 W/m <sup>2</sup>		
Pnom =	5.000 kW		
Tpv =	43.3 °C		
Tenv =	7.3 °C		
TOT	DC	AC	

Fig. 138: Example of result of a test carried out with MPP300.

Please see § 5.3.2 and § 10.1 for further information about the mathematic relationships used.

1. Press the **F2**, **F3** and **F4** keys to respectively display the Total, DC and AC input and output values of the inverter relevant to the maximum performance point.
2. Press the **ESC** key (or the smart icon ) to exit the function and go back to the “Recording Analysis” page (Fig. 134).

#### 5.7.2.4. Recording graph

By selecting the recording graph option, the following page is accessed, which enables the user to display the recording trend (ONLY ONE parameter at a time)

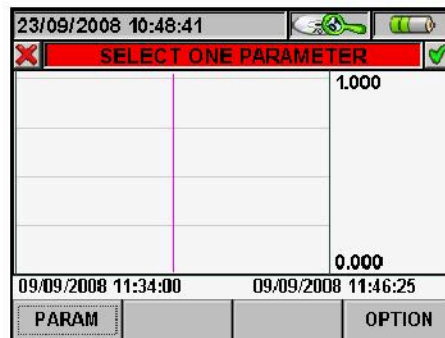

Fig. 139: Selecting a parameter

1. Press the **F1** key (or the **PARAM** item on the display) to access the page of selectable parameters (Fig. 140).

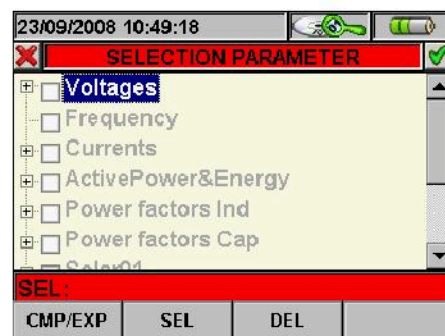



Fig. 140: Parameter selection

The following keys are active on this page:

- The up and down arrow keys move the cursor along the quantity tree
- The **F1** key (or the **CMP/EXP** item on the display) compresses and expands the tree of the quantity highlighted by the cursor
- The **F2** key (or the **SEL** item on the display) selects or deselects the parameter highlighted by the cursor
- The **ENTER** key (or the smart icon  on the display) confirms the selection previously performed and display the graph of the selected parameter (Fig. 141)
- The **CANC** key deselects the parameter previously selected, independently from the position of the cursor
- Press the **ESC** key (or the smart icon  on the display) to exit the function and go back to the "Selecting a parameter" page (Fig. 139)

This page shows graph, maximum RMS value, average RMS value and minimum RMS value of the selected parameter and the position of the cursor.





Fig. 141: Recording graph

The following keys are active on this page:

- The **F1** key (or the **PARAM** item on the display), to access the page of selectable parameters (Fig. 140)
- Press the **F2** key to see the characteristic parameters of the photovoltaic system relevant to the point considered. Information is similar to that described in § 5.7.2.2, but referred to the instant selected on the graph (i.e. the performance of the system in the instant considered and not necessarily the maximum performance previously described). This function is NOT available for recordings carried out with MPP300.
- The **F4** key (or the **OPTIONS** item on the display), to access the page for the activation of the “Advanced Graph” (Fig. 142)
- The **ESC** key (or the smart icon  on the display), to exit the function and go back to the “Recording analysis” page (Fig. 134)

Press the **F4** key (or the **OPTIONS** item on the display) to access the page for the activation of the Advanced Graph (Fig. 121):

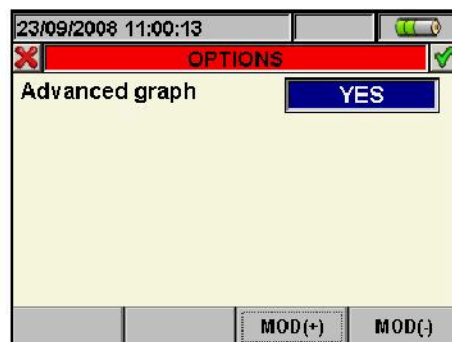



Fig. 142: Options (Advanced Graph)

The following keys are active on this page:

- The **F3** and **F4** keys (or the **MOD(+)** and **MOD(-)** items on the display) enable the user to choose **YES** or **NO** for the advanced graph
- The **ENTER** key (or the smart icon  on the display) confirms the selection previously made
- Press the **ESC** key (or the smart icon  on the display) to exit the function and go back to the “Selecting a parameter” page (Fig. 139)

### Example of advanced graph



Let us take a recording of 2000 pixels into consideration. The instrument has a display with a useful resolution of about 200 pixels; therefore, it is not able to distinctly display all the pixels in our recording. How does it operate then? The first pixel in the graph will be the analysis of the first 10 points in the recording, i.e. the highest of the 10 values will be selected as maximum value, the lowest of the values will be selected as minimum value and the average value will be the first of the series of samples, and so on, to create all other pixels in the graph.

### 5.7.3. Recording analysis (Istant type)

This page shows the analyses which can be performed on the saved data (Istant type).



Fig. 143: Recording analysis (Istant-type data)

1. Use the up and down arrow keys to highlight on blue background one of the analyses on the screen. Press the **F1** or **ENTER** key (or the **OPEN** item or the smart icon  on the display) to confirm the type of analysis to be performed.
2. Press the **ESC** key (or the smart icon  on the display) to exit the function and go back to the "Saved data" page (Fig. 115).

#### 5.7.3.1. Recording information

This page contains general information about the saved (Istant) file previously selected in the Saved Data Management MENU.



Fig. 144: Recording info

1. In these conditions, the **F1** key (or the **MODIFY** key on the display) is active and it is possible to modify and save the comment line by using the virtual keyboard (see § 5.4.2.2).
2. Press the **ESC** key (or the smart icon  on the display) to exit the function and go back to the "Recording analysis" page (Fig. 143).



### 5.7.3.2. Graph

This screen (Fig. 145) contemporarily shows the saved instant values of the waveforms of voltages V1, V2, V3, Vn scaled according to the Full scale (Fs) and the relevant RMS values; these values have been saved by the instrument upon pressing the **SAVE** key.

As an example, below are shown the screens relative to a **three phase 4-wire system**. Similar consideration can be applied to any other selected system.

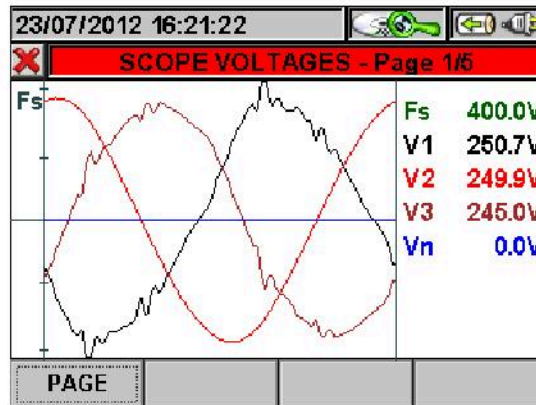

Fig. 145: Voltage scope in three-phase 4-wire system

The following keys are active on this page:

- The up (**ZOOM+**) or down (**ZOOM-**) arrow keys zoom in or out the displayed waveforms
- The **F1** key (or the **PAG** item on the display) advances to the following page of saved current values
- The **ESC** key (or the smart icon on the display) to exit the function and go back to the "Recording analysis" page (Fig. 143)

### 5.7.3.3. Harmonics analysis

This screen (Fig. 146) displays the harmonic values and the THD% value of voltages V1, V2, V3, Vn and of currents I1, I2, I3 and of Neutral current In in a graph (scaled according to the Full scale Fs) or in a table. The values displayed are percentage values of the fundamental or absolute values according to the configuration set in the **ANALYZER CONFIGURATION MENU → ADVANCED**. As an example, below are shown the screens relative to a **three phase 4-wire system**. Similar consideration can be applied to any other selected system

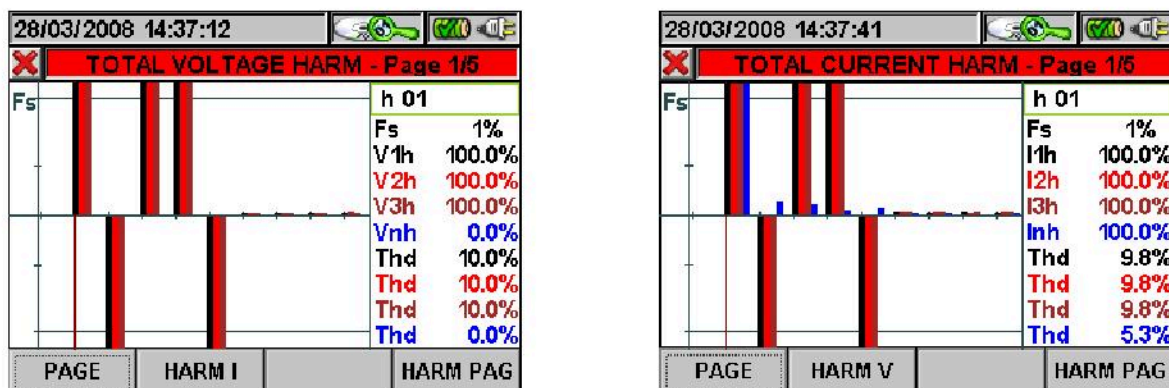



Fig. 146: Total harmonics in three-phase 4-wire system

Should only the voltage signals or only the current signals be connected to the instrument's inputs, all displayed harmonics will be shown in the upper half plane of the graph. If both voltage and current signals are connected to the instrument's inputs, the histogram bars representing the harmonics will be shown respectively:



- in the upper half plane of the graph if the harmonics are introduced into the relevant electrical system from the mains;
- in the lower half plane of the graph if the harmonics are injected into the relevant electrical system from the mains.

The following keys are active on this page:

- The up (**ZOOM+**) or down (**ZOOM-**) arrow keys zoom in or out the histogram.
- The right and left arrow keys move the cursor to the right or to the left along the harmonics.
- The **F1** key (or the **PAG** item on the display) advances to the following page of saved values, relative to phase 1 harmonics.
- The **F2** key (or the **ARM V** or **ARM I** item on the display) switches between total voltage and current harmonics.
- The **F4** key (or the **ARM PAG** item on the display) displays the following harmonics group. 0..9, 10..19, 20..29, 30..39, 40..49.
- The **ESC** key (or the smart icon  on the display) to exit the function and go back to the "Recording analysis" page (Fig. 143).

#### 5.7.3.4. Vectors

As an example, below are shown the screens relative to a **three phase 4-wire system**. Similar consideration can be applied to any other selected system. This screen (Fig. 147) displays, with graphic and numeric indications, the phase delays expressed in degrees [°] between:

- Voltage V1 and V2, V2 and V3, V3 and V1.
- Voltage V1 and current I1.
- Voltage V2 and current I2.
- Voltage V3 and current I3.

The latter allow finding out the inductive or capacitive nature of the electrical installation. In detail:

- positive angle: inductive load
- negative angle: capacitive load

The N-PE voltage (blue) and Neutral current vectors are also represented.

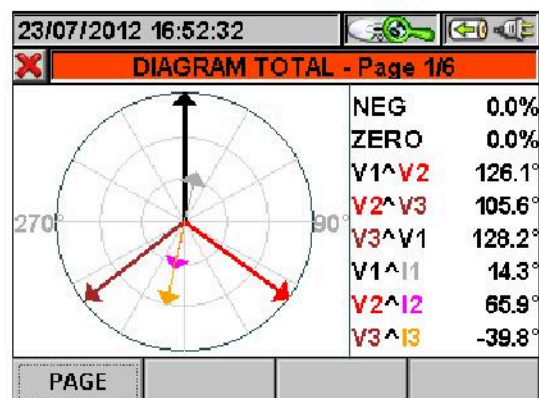



Fig. 147: Total vector diagram in three-phase 4-wire system

The following keys are active on this page:

- The **F1** key (or the **PAG** item on the display) advances to the following page of saved values relative to the voltage vector diagram.
- The **ESC** key (or the smart icon  on the display) to exit the function and go back to the "Recording analysis" page (Fig. 143).

### 5.7.3.5. Measures

As an example, below are shown the screens relative to a **three phase 4-wire system**. Similar consideration can be applied to any other selected system.

In measure mode, the instrument displays the saved values in TRMS as shown in the following figures:

28/03/2008 16:58:26				
TOTAL RMS VALUES - Page 1/5				
V1N	V2N	V3N	VNPE	V
230.9	231.0	231.0	0.0	V
V12	V23	V31		V
0.2	0.1	0.2		V
NEG%	ZERO%	SEQ	Hz	
50.8	100.0	132	50.0	
I1	I2	I3	IN	A
100.5	101.4	100.9	0.0	A
PAGE				

In this page, the following symbols are used:

**V1N** Neutral - Phase L1 Voltage.

**V2N** Neutral - Phase L2 Voltage.

**V3N** Neutral - Phase L3 Voltage.

**VNPE** Neutral - Ground Voltage.

**V12** Phase L1 - Phase L2 Voltage.

**V23** Phase L2 - Phase L3 Voltage.

**V31** Phase L3 - Phase L1 Voltage.

**Inv%** % value of the Negative sequence unbalance.

**Omo%** % value of the Zero sequence unbalance.

**SEQ** Phase sequence:

"123" => Correct.

"132" => Not correct.

"023" => No Voltage on B1.

"103" => No Voltage on B2.

"120" => No Voltage on B3.

"100" => No Voltage on B2 and B3.

"020" => No Voltage on B1 and B3.

"003" => No Voltage on B1 and B2.

**Hz** Frequency.

**I1** Current on phase L1.

**I2** Current on phase L2.

**I3** Current on phase L3.

**IN** Neutral current

Fig. 148: Page 1/5 of numeric values for three-phase 4-wire system

The following keys are active on this page:

- The **F1** key (or the **PAG** item on the display) advances to the following page of saved values.
- The **ESC** key (or the smart icon on the display) to exit the function and go back to the "Recording analysis" page (Fig. 143).

#### 5.7.4. Transfer recordings to a external Pen Driver USB

The meter permits to transfer of one or more saved recordings which are shown in Fig. 115 to a external Pen Driver USB directly connected to it (see Fig. 3). The below picture is shown by meter:

N.	Type	Time 1	Time 2
1	Rec	22/12/2014	22/12/2014
2	Rec	07/01/2015	07/01/2015
3	Rec	07/01/2015	07/01/2015
4	Snapshot	29/04/2015	15:40:00
5	Snapshot	29/04/2015	15:40:00
6	Snapshot	29/04/2015	15:41:00

INFO COPY DEL DEL ALL

Fig. 149: Recording results screen with Pen Driver USB connected



Press **F2** key (or the **COPY** now active at display). The below virtual keyboard screen, where the user can define the file name to save inside Pen Driver USB, is shown by meter:

File Name

001\_2014-12-22|

a	b	c	d	e	f	g	h
i	j	k	l	m	n	o	p
q	r	s	t	u	v	w	x
y	z		<-	az	Sb	123	Cap

Fig. 150: Definition of file name which is saved on Pen Driver USB

Press **SAVE** or **ENTER** keys (or the smart icon ) to confirm the file name or press **ESC** key (or the smart icon ) to exit without saving. In case of file just exist inside Pen Driver USB, the below warning message is shown by meter:

Warning

File name already existing. Overwrite?

Ok Cancel

Fig. 151: Confirm to overwrite file

Press "Ok" to overwrite the file name or "Cancel" to exit without modify. Press **ESC** key (or the smart icon ) to back to GENERAL MENU screen.



### 5.7.5. Saving recordings to external Compact Flash

The instrument permits to save the recordings also on external standard compact flash which are fitted on suitable input (see Fig. 3) after activating “EXTERNAL” option on **Memory type** (see § 5.1.7). The following is shown by meter:

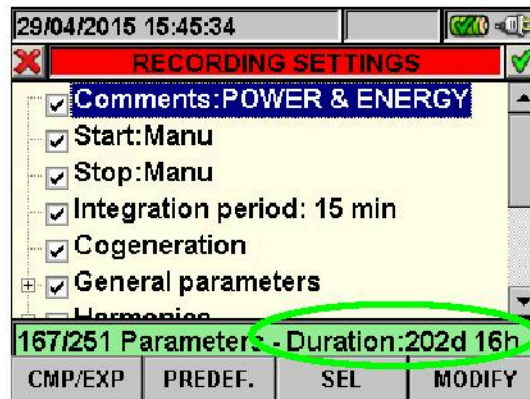



Fig. 152: Example of use of external memory - compact flash not fitted

In the example of Fig. 152 a “POWER & ENERGY predefined configuration with an autonomy of 202d 16h in condition of compact flash not fitted was been considered. Insert compact flash on meter, exit from the above screen by pressing **ESC** key (or the smart icon ) and open again the same screen, the below screen is shown by meter:

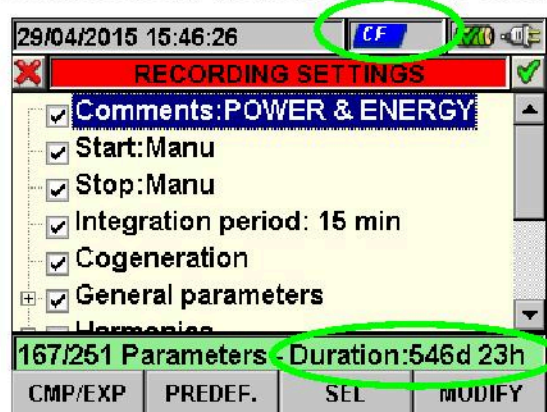

Fig. 153: Example of use of external memory - compact flash fitted

The correspondent icon is shown by meter in the top of display after fitted the Compact Flash on meter and the value of autonomy is automatically updated at display (546d 23h in the example of Fig. 153).



### CAUTION

The passage from internal memory (about 15Mbytes) to external memory with compact flash option permits to save a recording with size up to **32Mbytes** independently on dimension in Mbytes size of compact flash.

## 5.8. METER INFORMATION

Inside this section the general internal parameters of meter are available as information from the user for example during any contact with Service people of HT.

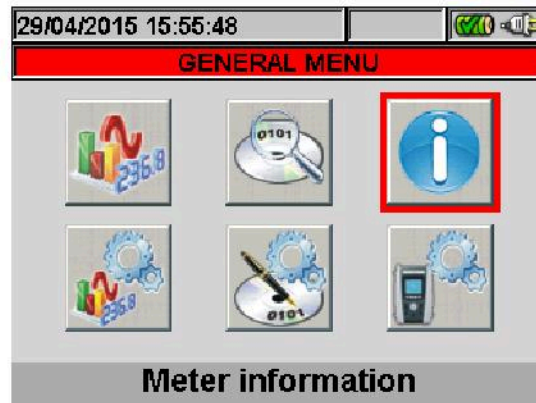

Fig. 154: Menu General screen – Meter information section

Press **ENTER** key or touch the correspondent icon at display. The below screen is shown by meter:

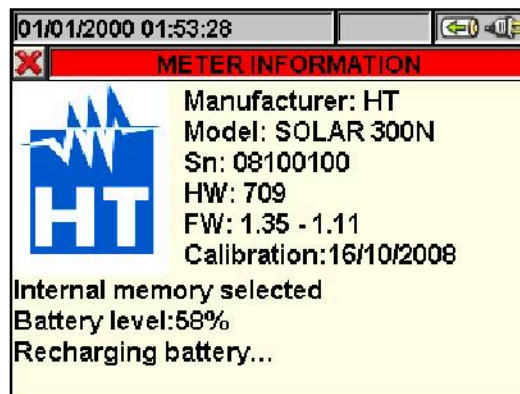



Fig. 155: Meter information screen

The following meaning of the items inside the above screen:

Item	Description
Manufacturer	Name of manufacturer
Model	Name of model
Sn	Serial number of meter
Hw	Internal Hardware version of meter
Fw	Internal Firmware version of meter
Calibration	Date of last calibration performed
Selection of type of memory	Internal or external memory
Battery charge level	Percentage of charge level of battery

In case the instrument is connected to the (optional) external unit MPP300 via USB cable, the information relevant to the unit MPP300 itself will be displayed instead.

Press **ESC** key (or smart icon ) to back to GENERAL MENU screen.

## 6. CONNECTION OF METER TO PC (WIN XP)

1. Install the **TopView** standard software on your PC.
2. Verify the presence of ActiveSync icon with **grey** background (not active) on the right bottom part of PC screen as shown in below picture:



Fig. 156: ActiveSync icon not active

3. Connect the meter to PC using the standard C2007 cable (USB "A" → USB "B") as shown in below screen:

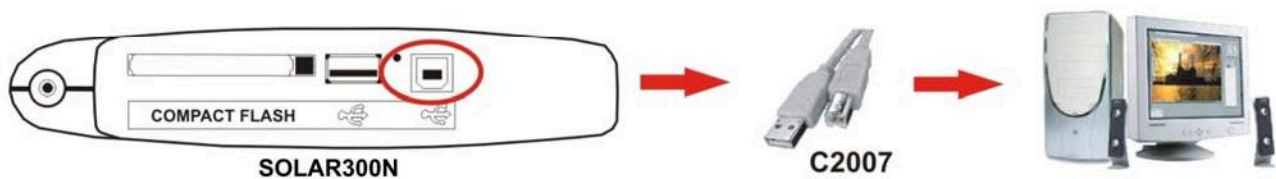

Fig. 157: Connection of meter to PC

4. Verify the presence of ActiveSync icon with **green** background (active) on the right bottom part of PC screen as shown in below picture. Only in this order the connection of meter to PC is correct



Fig. 158: ActiveSync icon active

5. Run **TopView** software and click on "**Instrument <-> PC connection**" key. Press the "Select new instrument" key in software screen in order to acknowledge the name of connected meter, which is shown in the bottom status bar. Select "SOLAR300N" model from the available list of meters only for the first connection.
6. Select the "Download data" command and pressing "Next" key in order to open the "**Download**" windows on software which the all saved data by meter are shown. Select one or more desired recordings and click on "Download" key.
7. Downloading procedure is start and the total recording analysis window is shown by software at the end of this operation.

**For any detail about use please refer to TopView HELP ON LINE feature**

### CAUTION



- During a recording running is not possible to perform the download of data to PC. Press **GO/STOP** key on meter to stop recording before download operation
- Let the meter always in GENERAL MENU screen to perform the dual communication between meter and PC



## 7. MEASURING PROCEDURES

The instrument's accuracy in PV systems is granted only for the following system configuration:

### PV (Photovoltaic) systems

- Single-phase (Phase, Neutral, Earth)
- Three-phase (Three-phase 120° + Earth)

Further in this manual, the following definitions will be used, relative to PV systems

- **Test:** check the DC and AC efficiency parameters of a PV installation by using a **fixed (and not changeable) IP = 5s** in quick way. No selection of recording parameters by the user is necessary. For testing purposes, the connection of the unit SOLAR-0x and relevant probes is strictly necessary. Furthermore, the solar irradiation measured will have to exceed the minimum irradiance threshold (see § 5.3.3.3)
- **Recording:** Recording the DC and AC efficiency parameters of a PV installation by using a IP selected by the user (see § 5.4.2.4). The connection of the unit SOLAR-0x and relevant probes is strictly necessary. Furthermore, the solar irradiation measured will have to exceed the minimum irradiance threshold (see § 5.3.3.3)

For the sake of simplicity, further in this manual, the word “string” will be used, although often the term “photovoltaic field” would be more correct. From the point of view of the instrument, the management of a single string or of more parallel strings (photovoltaic field) is identical. Furthermore, the acronym **MPPT** (Multiple Power Point Tracker) shall indicate the characteristic of the DC/AC converter (inverter), capable of maximizing the DC power which can be taken from the photovoltaic field and the acronym **PRp** shall indicate the Performance Ratio evaluated through active powers. See the § 10.3 for further details.

In case of test / recording on PV systems realized by means of Multi-MPPT (**multi-string**) inverter, it will be possible to proceed as follows:

- Divide the system into more “sections” (one for each MPPT) and to test them individually one after the other by appropriately sectioning the photovoltaic fields not involved in the measurement.

Or

- Use the (optional) external unit MPP300, capable of managing the measurement up to 3 separate photovoltaic fields at the same time, each connected to an MPPT of the inverter.



### CAUTION

For the evaluation of the PRp only, the measurement of the DC (voltage and current) is not strictly necessary. Conversely it is necessary if you want to evaluate the performance of the photovoltaic section (ndc) and DC / AC conversion (nac)

## 7.1. TEST/RECORDING OF PV-1 SYSTEM WITH REMOTE UNIT SOLAR-01

**CAUTION**

- The maximum voltage between inputs D1, D2, A1, A2 and A3 is 1000V / CAT IV 600V to earth. Do not measure voltages exceeding the limits indicated in this manual. If these voltage limit values are exceeded, the user may be exposed to electrical shocks and the instrument could get damaged
- Where possible, disconnect the connecting points of the instrument, before connecting it, by means of disconnecting switches S1 and S2

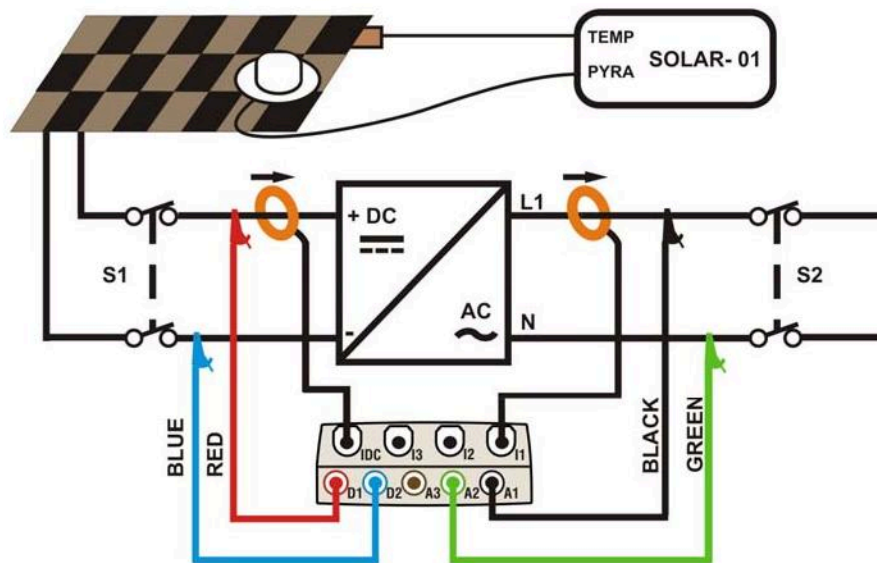

Fig. 159: Connecting the instrument in a PV-1 system with SOLAR-01

1. Check and, if necessary, change the basic settings of the instrument relative to **PV-1** configuration (see § 5.3.1, 5.3.2 and 5.3.3). Also check that the parameters of the photovoltaic system considered correspond to the set values
2. Connect inputs **D1** and **D2** to the positive and negative string output pole respectively. Connect inputs **A1** and **A2** to the phase and neutral conductors, respecting the colors as shown in Fig. 159



**CAUTION**

**BEFORE CONNECT DC CLAMP ON CONDUCTOR**

Turn on the clamp, select the correct range and press the ZERO key to the DC clamp in order to eliminate possible residual magnetizations in the clamp (values of current up to 0.02A are acceptable). Connect the output of the clamp to the IDC input of the instrument

3. Connect the DC current clamp to the positive string output conductor **by respecting the direction of the arrow** on the clamp itself as indicated in Fig. 159. **Check the status of internal batteries of the DC clamp after the connection to the installation**
4. Connect the AC current clamp to the Phase L1 conductor **by respecting the direction of the arrow** on the clamp itself as indicated in Fig. 159. Connect the output of the clamp to the I1 input of the instrument.



5. Supply the electric system considered in case it was temporarily put out of service for connecting the instrument
6. Check that the active power  $P_{ac}$  is positive and that the power factor  $P_f$  corresponds to the load (typically equal to 1.00 for measures made downstream the inverter in photovoltaic systems). In case of negative values of the active power open the clamp, rotate it by  $180^\circ$  and connect it again to the conductor
7. Turn on the **SOLAR-01** unit by means of the relevant key on the unit itself. SOLAR-01 will switch to stand-by mode (**STATUS LED** flashing)
8. Connect the SOLAR-01 unit to the main unit by means of the USB cable. The main unit must display the message "SOLAR-01 connected". Should this message not appear, disconnect and connect again the USB connector
9. **Press the F1 key (GO/STOP key for recording) to start the test or recording on a PV system** (see § 5.5). The icon  is shown on the display of instrument and the **LED REC** flashing on unit SOLAR-01 (further to the STATUS LED, already flashing). For the meaning of the flashing of the SOLAR-01 LEDs refer to § 8.2
10. **Whenever the icon  will appear on the display of instrument from the beginning of the first minute after pressing the F1 key** the test has been started on a photovoltaic system. Disconnect the SOLAR-01 from main unit and bring it near the photovoltaic cells
11. Position the pyranometer on the plane of the photovoltaic panels and the temperature sensor typically in contact with the back of the panel, fixed by tape and do not touch it to avoid a wrong measurement
12. Connect the irradiation and temperature probes respectively to the inputs **PYRA** and **TEMP** of the SOLAR-01 unit. Wait some seconds in order to permits a stable measure by probes
13. Wait for the **READY LED** to start flashing. This event indicated that the instrument has detected some data with solar irradiation  $>$  minimum limit threshold (see § 5.3.3.3)
14. **Wait at least 1 minute in order to recording more valid samples** than disconnect the irradiation and temperature probes from the SOLAR-01 unit, bring the SOLAR-01 unit next to the to the main unit and connect them by means of the USB cable. The main unit must display the message "SOLAR-01 connected" (should this message not appear, disconnect and connect again the USB connector)
15. Press the **F1** key (FINISH) or **GO/STOP** key on the instrument to stop the test/recording
16. After the automatic data transfer phase, the instrument:
  - Do not show any results if do not exist on the PV installation a "**stable irradiance**" condition more than the minimum irradiance threshold (see § 5.3.3.3)
  - Display the best performance values if during the recording, the Irradiance values reached the "**stable**" condition and its values were higher than the minimum irradiance threshold (see § 5.3.3.3)
17. Press **SAVE** to save the results obtained. Pressing the key will display the virtual keyboard for typing possible comments. A further pressing of the **SAVE** key will store the measure and the typed comments and will go back to the initial screen, ready for a new measurement
18. Press **ESC** to delete the detected data and go back to the initial screen, ready for a new measurement



## 7.2. TEST/RECORDING OF PV-1 SYSTEM WITH REMOTE UNIT SOLAR-02

**CAUTION**

- The maximum voltage between inputs D1, D2, A1, A2 and A3 is 1000V / CAT IV 600V to earth. Do not measure voltages exceeding the limits indicated in this manual. If these voltage limit values are exceeded, the user may be exposed to electrical shocks and the instrument could get damaged
- Where possible, disconnect the connecting points of the instrument, before connecting it, by means of disconnecting switches S1 and S2

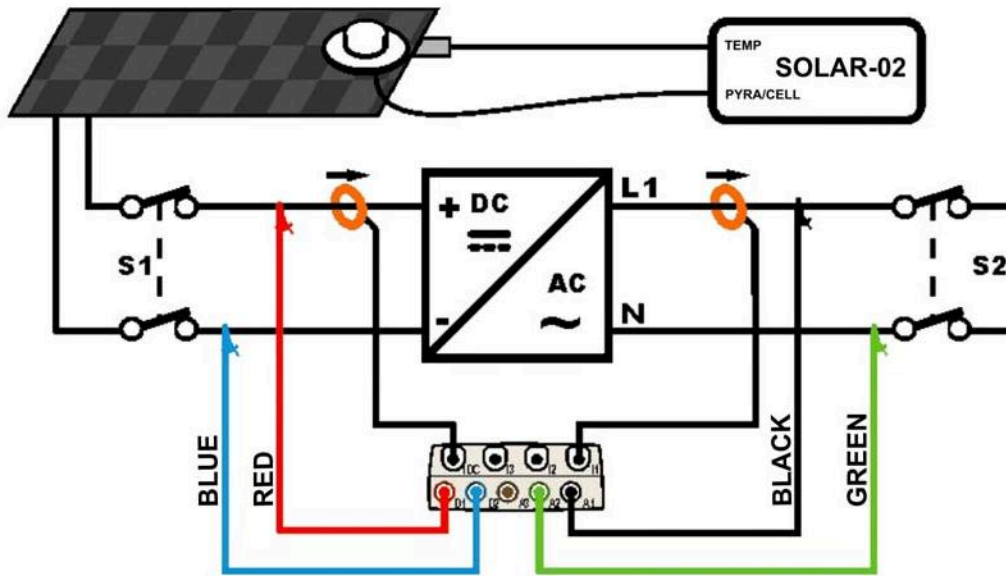

Fig. 160: Connecting the instrument in a PV-1 system with SOLAR-02



1. Check and, if necessary, change the basic settings of the instrument relative to **PV-1** configuration (see § 5.3.1, 5.3.2 and 5.3.3). Also check that the parameters of the photovoltaic system considered correspond to the set values. For setting of pyranometer or reference cell sensitivity please refer to the user manual of SOLAR-02
2. Use the remote unit SOLAR-02 in independent mode to perform a possible preliminary measurement of irradiance
3. Connect inputs **D1** and **D2** to the positive and negative string output pole respectively. Connect inputs **A1** and **A2** to the phase and neutral conductors, respecting the colors as shown in Fig. 160

**CAUTION**

**BEFORE CONNECT DC CLAMP ON CONDUCTOR**

Turn on the clamp, select the correct range and press the ZERO key to the DC clamp in order to eliminate possible residual magnetizations in the clamp (values of current up to 0.02A are acceptable). Connect the output of the clamp to the IDC input of the instrument

4. Connect the DC current clamp to the positive string output conductor **by respecting the direction of the arrow** on the clamp itself as indicated in Fig. 160. **Check the status of internal batteries of the DC clamp after the connection to the installation**
5. Connect the AC current clamp to the Phase L1 conductor **by respecting the direction of the arrow** on the clamp itself as indicated in Fig. 160. Connect the output of the clamp to the I1 input of the instrument.

6. Supply the electric system considered in case it was temporarily put out of service for connecting the instrument
7. Check that the active power Pac is positive and that the power factor Pf corresponds to the load (typically equal to 1.00 for measures made downstream the inverter in photovoltaic systems). In case of negative values of the active power open the clamp, rotate it by 180° and connect it again to the conductor
8. Turn on the **SOLAR-02** unit by means of the relevant key on the unit itself. The unit will remain on hold. Select the type of irradiance sensor on the unit (see § 4.5 of SOLAR-02 user manual).
9. Connect the SOLAR-02 unit to the main unit by means of the USB cable. The main unit must display the message "SOLAR-02 connected". Should this message not appear, disconnect and connect again the USB connector
10. **Press the F1 key (GO/STOP key for recording) to start the test or recording on a PV system** (see § 5.5). The icon  is shown on the display of instrument and the "HOLD" message along with the waiting time to reach the "00" instant condition are displayed on SOLAR-02 unit
11. **Whenever the icon  will appear on the display of instrument from the beginning of the first minute after pressing the F1 key** the test has been started on a photovoltaic system. Disconnect the SOLAR-02 from main unit and bring it near the photovoltaic cells. The "Recording..." message is displayed on SOLAR-02.
12. Position the pyranometer on the plane of the photovoltaic panels. In case of use of reference cell please refer to § 4.2 of its user manual for a correct fixing
13. Position the temperature sensor typically in contact with the back of the panel, fixed by tape and do not touch it to avoid a wrong measurement
14. Connect the irradiation and temperature probes respectively to the inputs **PYRA/CELL** and **TEMP** of the SOLAR-02 unit. Wait some seconds in order to permits a stable measure by probes
15. Wait for "READY" message displayed on SOLAR-02. This event indicates that the instrument has detected some data with solar irradiation > minimum limit threshold (see § 5.3.3.3).
16. **Wait at least 1 minute in order to recording more valid samples** than disconnect the irradiation and temperature probes from the SOLAR-02 unit, bring the SOLAR-02 unit next to the to the main unit and connect them by means of the USB cable. The main unit must display the message "SOLAR-02 connected" (should this message not appear, disconnect and connect again the USB connector)
17. Press the **F1** key (FINISH) or **GO/STOP** key on the instrument to stop the test/recording
18. After the automatic data transfer phase, the instrument:
  - Do not show any results if do not exist on the PV installation a "**stable irradiance**" condition more than the minimum irradiance threshold (see § 5.3.3.3)
  - Display the best performance values if during the recording, the Irradiance values reached the "**stable**" condition and its values were higher than the minimum irradiance threshold (see § 5.3.3.3)
19. Press **SAVE** to save the results obtained. Pressing the key will display the virtual keyboard for typing possible comments. A further pressing of the **SAVE** key will store the measure and the typed comments and will go back to the initial screen, ready for a new measurement
20. Press **ESC** to delete the detected data and go back to the initial screen, ready for a new measurement



## 7.3. TEST/RECORDING OF PV-3 SYSTEM WITH REMOTE UNIT SOLAR-01

**CAUTION**

- The maximum voltage between inputs D1, D2, A1, A2 and A3 is 1000V / CAT IV 600V to earth. Do not measure voltages exceeding the limits indicated in this manual. If these voltage limit values are exceeded, the user may be exposed to electrical shocks and the instrument could get damaged
- Where possible, disconnect the connecting points of the instrument, before connecting it, by means of disconnecting switches S1 and S2

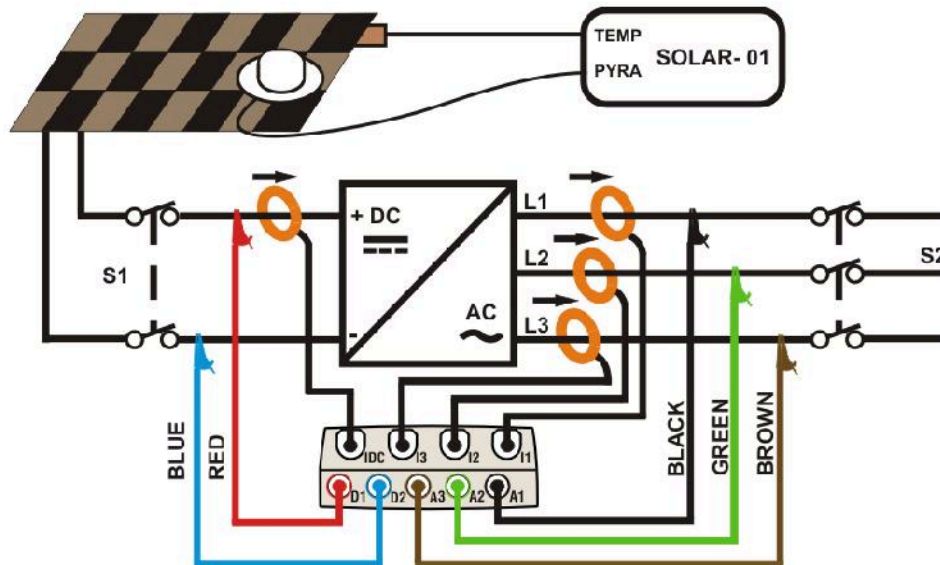

Fig. 161: Connecting the instrument to a PV-3 system with SOLAR-01

1. Check and, if necessary, change the basic settings of the instrument relative to **PV-3** configuration (see § 5.3.1, 5.3.2 and 5.3.3). Also check that the parameters of the photovoltaic system considered correspond to the set values
2. Connect inputs **D1** and **D2** to the positive and negative string output pole respectively. Connect inputs **A1**, **A2** and **A3** to the phase conductors, respecting the colors as shown in Fig. 161



**CAUTION**

**BEFORE CONNECT DC CLAMP ON CONDUCTOR**

Turn on the clamp, select the correct range and press the **ZERO** key to the DC clamp in order to eliminate possible residual magnetizations in the clamp (values of current up to 0.02A are acceptable). Connect the output of the clamp to the IDC input of the instrument

3. Connect the DC current clamp to the positive string output conductor **by respecting the direction of the arrow** on the clamp itself as indicated in Fig. 161. **Check the status of internal batteries of the DC clamp after the connection to the installation**
4. Connect the AC clamps to the Phase L1, L2, L3 conductors **by respecting the direction of the arrow** on the clamps as indicated in Fig. 161. Connect the output of the clamps to the **I1**, **I2**, **I3** input of the instrument respectively
5. Supply the electric system considered in case it was temporarily put out of service for connecting the instrument



6. Check that the active power  $P_{ac}$  is positive and that the power factor  $Pf$  corresponds to the load (typically equal to 1.00 for measures made downstream the inverter in photovoltaic systems). In case of negative values of the active power, check the connection of the amperometric clamps. In case of doubt, to check the connections made, it can be useful to **temporarily modify the settings and the connections** of the instrument in order to perform a measurement in three-phase 3-wire mode downstream the inverter (see par. 5.3.1 and 7.8)
7. Turn on the **SOLAR-01** unit by means of the relevant key on the unit itself. SOLAR-01 will switch to stand-by mode (**STATUS LED** flashing) Turn on the **SOLAR-01** unit by means of the relevant key on the unit itself. SOLAR-01 will switch to stand-by mode (**STATUS LED** flashing)
8. Connect the SOLAR-01 unit to the main unit by means of the USB cable. The main unit must display the message "SOLAR-01 connected". Should this message not appear, disconnect and connect again the USB connector
9. **Press the F1 key (GO/STOP key for recording) to start the test or recording on a PV system** (see § 5.5). The icon  is shown on the display of the main unit and the **LED REC** flashing on unit SOLAR-01 (further to the STATUS LED, already flashing). For the meaning of the flashing of the SOLAR-01 LEDs refer to §
10. **Whenever the icon  will appear on the display of instrument from the beginning of the first minute after pressing the F1 key** the test has been started on a photovoltaic system. Disconnect the SOLAR-01 from the main unit and bring it near the photovoltaic cells
11. Position the pyranometer on the plane of the photovoltaic panels and the temperature sensor typically in contact with the back of the panel, fixed by tape and do not touch it to avoid a wrong measurement
12. Connect the irradiation and temperature probes respectively to the inputs **PYRA** and **TEMP** of the SOLAR-01 unit. Wait some seconds in order to permits a stable measure by probes
13. Wait for the **READY LED** to start flashing. This event indicated that the instrument has detected some data with solar irradiation > minimum limit threshold (see § 5.3.3.3).
14. **Wait at least 1 minute in order to recording more valid samples** than disconnect the irradiation and temperature probes from the SOLAR-01 unit, bring the SOLAR-01 unit next to the to the main unit and connect them by means of the USB cable. The main unit must display the message "SOLAR-01 connected" (should this message not appear, disconnect and connect again the USB connector)
15. Press the **F1** key (FINISH) or **GO/STOP** key on the instrument to stop the test/recording
16. After the automatic data transfer phase, the instrument:
  - Do not show any results if do not exist on the PV installation a "**stable irradiance**" condition more than the minimum irradiance threshold (see § 5.3.3.3)
  - Display the best performance values if during the recording, the Irradiance values reached the "**stable**" condition and its values were higher than the minimum irradiance threshold (see § 5.3.3.3)
17. Press **SAVE** to save the results obtained. Pressing the key will display the virtual keyboard for typing possible comments. A further pressing of the **SAVE** key will store the measure and the typed comments and will go back to the initial screen, ready for a new measurement
18. Press **ESC** to delete the detected data and go back to the initial screen, ready for a new measurement

## 7.4. TEST/RECORDING OF PV-3 SYSTEM WITH REMOTE UNIT SOLAR-02

**CAUTION**

- The maximum voltage between inputs D1, D2, A1, A2 and A3 is 1000V / CAT IV 600V to earth. Do not measure voltages exceeding the limits indicated in this manual. If these voltage limit values are exceeded, the user may be exposed to electrical shocks and the instrument could get damaged
- Where possible, disconnect the connecting points of the instrument, before connecting it, by means of disconnecting switches S1 and S2

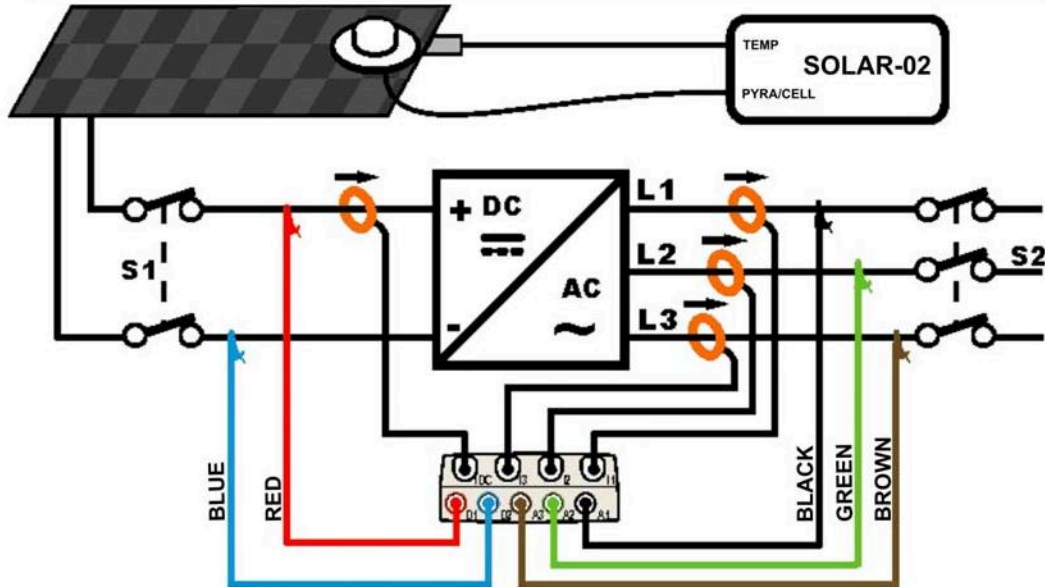

Fig. 162: Connecting the instrument to a PV-3 system with SOLAR-02

1. Check and, if necessary, change the basic settings of the instrument relative to **PV-3** configuration (see § 5.3.1, 5.3.2 and 5.3.3). Also check that the parameters of the photovoltaic system considered correspond to the set values. For setting of pyranometer or reference cell sensitivity please refer to the user manual of SOLAR-02
2. Use the remote unit SOLAR-02 under independent mode to perform a possible preliminary measurement of irradiance.



**CAUTION**

**BEFORE CONNECT DC CLAMP ON CONDUCTOR**

Turn on the clamp, select the correct range and press the ZERO key to the DC clamp in order to eliminate possible residual magnetizations in the clamp (values of current up to 0.02A are acceptable). Connect the output of the clamp to the IDC input of the instrument

3. Connect inputs **D1** and **D2** to the positive and negative string output pole respectively. Connect inputs **A1**, **A2** and **A3** to the phase conductors, respecting the colors as shown in Fig. 162
4. Connect the DC current clamp to the positive string output conductor **by respecting the direction of the arrow** on the clamp itself as indicated in Fig. 162. **Check the status of internal batteries of the DC clamp after the connection to the installation**
5. Connect the AC clamps to the Phase L1, L2, L3 conductors **by respecting the direction of the arrow** on the clamps as indicated in Fig. 162. Connect the output of the clamps to the **I1**, **I2**, **I3** input of the instrument respectively
6. Supply the electric system considered in case it was temporarily put out of service for connecting the instrument



7. Check that the active power  $P_{ac}$  is positive and that the power factor  $Pf$  corresponds to the load (typically equal to 1.00 for measures made downstream the inverter in photovoltaic systems). In case of negative values of the active power, check the connection of the amperometric clamps. In case of doubt, to check the connections made, it can be useful to **temporarily modify the settings and the connections** of the instrument in order to perform a measurement in three-phase 3-wire mode downstream the inverter (see par. 5.3.1 and 7.8)
8. Turn on the **SOLAR-02** unit by means of the relevant key on the unit itself. The unit will remain on hold. Select the type of irradiance sensor on the unit (see § 4.5 of SOLAR-02 user manual).
9. Connect the SOLAR-02 unit to the main unit by means of the USB cable. The main unit must display the message "SOLAR-02 connected". Should this message not appear, disconnect and connect again the USB connector
10. **Press the F1 key (GO/STOP key for recording) to start the test or recording on a PV system** (see § 5.5). The icon  is shown on the display of instrument and the "HOLD" message along with the waiting time to reach the "00" instant condition are displayed on SOLAR-02 unit
11. **Whenever the icon  will appear on the display of instrument from the beginning of the first minute after pressing the F1 key** the test has been started on a photovoltaic system. Disconnect the SOLAR-02 from main unit and bring it near the photovoltaic cells. The "Recording..." message is displayed on SOLAR-02.
12. Position the pyranometer on the plane of the photovoltaic panels. In case of use of reference cell please refer to § 4.2 of its user manual for a correct fixing
13. Position the temperature sensor typically in contact with the back of the panel, fixed by tape and do not touch it to avoid a wrong measurement
14. Connect the irradiation and temperature probes respectively to the inputs **PYRA/CELL** and **TEMP** of the SOLAR-02 unit. Wait some seconds in order to permits a stable measure by probes
15. Wait for "READY" message displayed on SOLAR-02. This event indicated that the instrument has detected some data with solar irradiation > minimum limit threshold (see § 5.3.3.3)
16. **Wait at least 1 minute in order to recording more valid samples** than disconnect the irradiation and temperature probes from the SOLAR-02 unit, bring the SOLAR-02 unit next to the to the main unit and connect them by means of the USB cable. The main unit must display the message "SOLAR-02 connected" (should this message not appear, disconnect and connect again the USB connector)
17. Press the **F1** key (FINISH) or **GO/STOP** key on the instrument to stop the test/recording
18. After the automatic data transfer phase, the instrument:
  - Do not show any results if do not exist on the PV installation a "**stable irradiance**" condition more than the minimum irradiance threshold (see § 5.3.3.3)
  - Display the best performance values if during the recording, the Irradiance values reached the "**stable**" condition and its values were higher than the minimum irradiance threshold (see § 5.3.3.3)
19. Press **SAVE** to save the results obtained. Pressing the key will display the virtual keyboard for typing possible comments. A further pressing of the **SAVE** key will store the measure and the typed comments and will go back to the initial screen, ready for a new measurement
20. Press **ESC** to delete the detected data and go back to the initial screen, ready for a new measurement



### 7.5. TEST/RECORDING OF PV WITH MPPT – SINGLE/THREE PHASE AC

The instrument SOLAR300N, used together with remote units SOLAR-02 and MPP300 (optional), allows testing PV systems characterized by 1 or more PV fields (with the same direction and inclination), each connected to an MPPT of the inverter (see § 10.3) and single-phase or three-phase output. The remote unit MPP300 is capable of communicating with SOLAR300N via USB cable (to manage data synchronization and download) and with the remote unit SOLAR-02 (for recording irradiation and temperature values) via a wireless radiofrequency (RF) connection, which is active up to a maximum distance of 1m between the units.

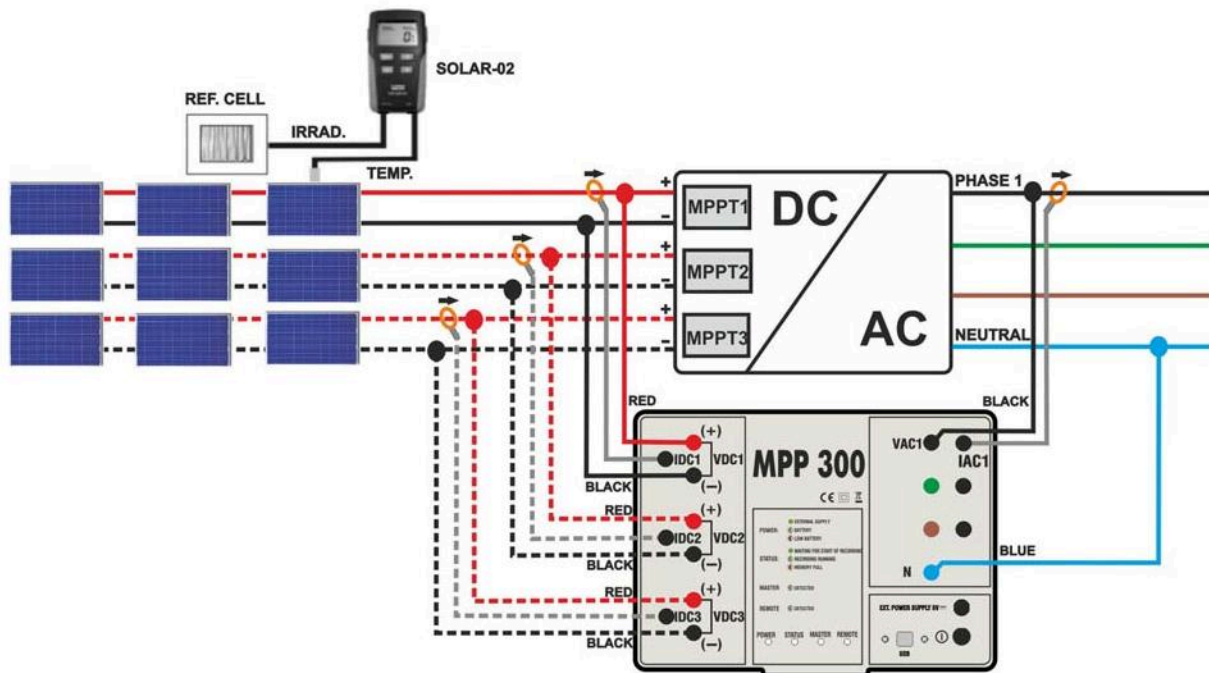

Fig. 163: Connection of MPP300 for testing a single-phase PV system

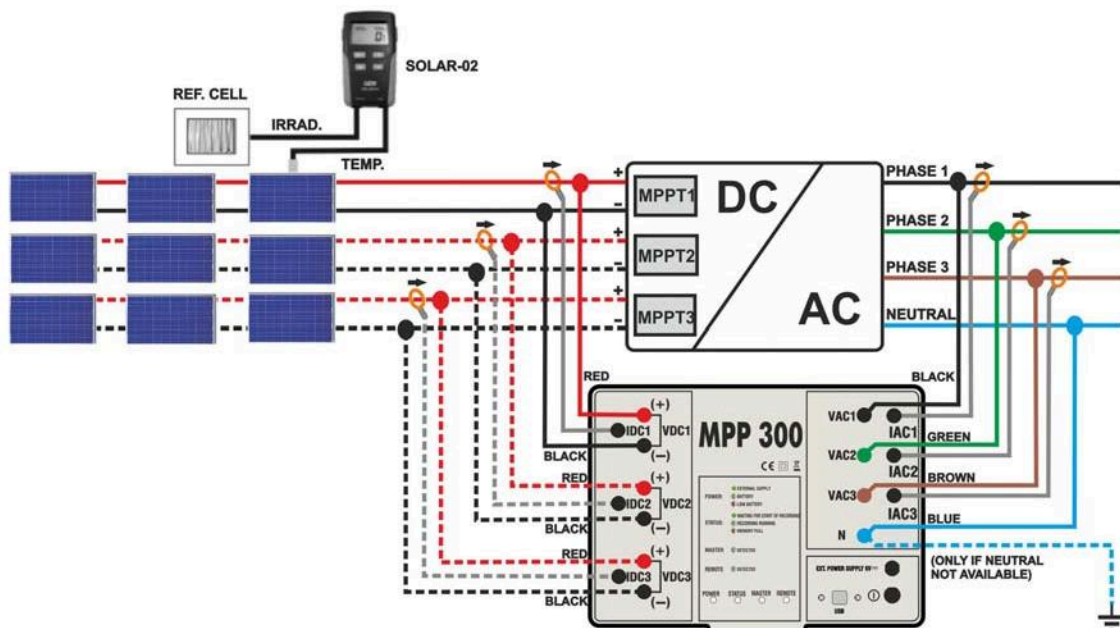



Fig. 164: Connection of MPP300 for testing a three-phase PV system

### CAUTION



- When SOLAR300N is set in order to use MPP300 as a remote unit, ALL connections relevant to electrical quantities (voltages and currents) must be carried out on unit **MPP300**. SOLAR300N must have **no voltage nor current** connected to its inputs.
- The maximum voltage for the inputs of **MPP300** is **1000VDC** between inputs VDC1, VDC2, VDC3 and **600VAC** between inputs VAC1, VAC2, VAC3. Do not measure voltages exceeding the limits given in this manual. Exceeding these limits could result in electrical shocks to the user and damage to the instrument.
- In order to guarantee the operator's safety, while making the connections, disable the system being measured by means of the switches/breakers upstream and downstream of the DC/AC converter (inverter).

1. Check and, if necessary, set the sensitivity of the reference cell on SOLAR-02 consistently with the type of PV modules which will be measured (please refer to the User Manual of SOLAR-02).
2. We recommend making a preliminary evaluation of the value of irradiation on the surface of the PV modules being tested by means of unit SOLAR-02 (operating independently) and the reference cell. We suggest carrying out the tests only if irradiation is higher than  $600\text{W}/\text{m}^2$
3. Switch on SOLAR300N, check and, if necessary, change the settings relevant to the type of remote unit, to the minimum irradiation threshold, to the full scale of the AC and DC clamps and to the parameters of the system being measured (see §5.3.3.1, §5.3.3.3, §5.3.1.2, §5.3.1.3, §5.3.2).
4. In order to guarantee the operator's safety, disable the system being measured by means of the switches/breakers upstream and downstream of the DC/AC converter (inverter).
5. Connect SOLAR300N to the MPP300 unit via the USB cable and bring SOLAR-02 and MPP300 nearer (max distance approx. 1 m). **All instruments must be switched on** (see the User Manuals of SOLAR-2 and MPP300 for further details). The display of SOLAR300N must show (for 5 seconds) the message "**MPP300 connected**".
6. On SOLAR300N, access the **GENERAL MENU**, select the function **View Measures** and press **ENTER**; wait for the three units to start communicating with each other. This condition is highlighted by the contemporary presence of the following indicators:
  - a. Symbol  steady (not flashing) on the display of SOLAR-02
  - b. **MASTER** and **REMOTE** LEDs flashing green on unit MPP300
7. Fig. 163 Fig. 164 Connect the **VDC1(+)** and **VDC1(-)** inputs of unit **MPP300** to the output terminals of the string, respecting the polarities and the colours indicated in Fig. 163 or Fig. 164.
8. Repeat the operation described in the step above for other possible DC power trackers to be monitored by using the **VDC2** and **VDC3** inputs according to the number of DC inputs set (see § 5.3.2.5).
9. Connect the output connector of the DC clamp to the **IDC1** input of unit MPP300



## CAUTION



**BEFORE CONNECTING THE DC CLAMPS TO THE CONDUCTORS**

Switch on the clamp, check the LED indicating the status of the clamp's internal batteries (if present), select the correct range, press the ZERO key on the DC clamp and check on the display of SOLAR300N the actual zeroing of the corresponding Idc value (values up to 0.02A are acceptable).

10. **Fig. 164** Insert the DC current clamp onto the positive output conductor of the string, **respecting the direction of the arrow** found on the clamp itself as indicated in Fig. 163 or Fig. 164. Position the clamp toroid as far as possible from the inverter and from the negative output conductor of the string itself.
11. Repeat the operations described in the two steps above for other possible DC power trackers to be monitored by using the **IDC2** and **IDC3** inputs according to the number of DC inputs set (see § 5.3.2.5).
12. Connect the **VAC1** and **N** inputs of unit **MPP300** to the Phase and Neutral conductors respectively, respecting the polarities and the colours indicated in Fig. 163 or Fig. 164. In case of three-phase systems in which no Neutral conductor is available, connect input **N** to earth.
13. In case of inverter with three-phase output (see settings in § 5.3.1), repeat the operation described in the step above for the remaining phases by using the **VAC2** and **VAC3** inputs of MPP300.
14. **Fig. 164** Connect the AC clamp to the Phase L1 conductor, **respecting the direction of the arrow** found on the clamp itself as indicated in Fig. 163. and/or Fig. 164. Position the clamp toroid as far as possible from the inverter and from the Neutral conductor. Connect the clamp output to the **IAC1** input of MPP300.
15. In case of inverter with three-phase output (see settings in § 5.3.1), repeat the operation described in the step above for the remaining phases by using the **IAC2** and **IAC3** inputs of MPP300.
16. Restore the operation of the electrical system being measured.

17. The display of SOLAR300N will show the values of the **general** electrical parameters of the system being measured.

In particular, in this screen:

Pdc = General dc power (sum of the string powers)

Pac = ac power (if single-phase) or sum of the ac powers (if three-phase)

We recommend checking that the values of the electrical parameters (Pnom, Pdc, Pac) and of the ac performance ( $\eta_{ac}$ ) are consistent with the system being measured (e.g.:  $\eta_{ac} > 1$  is not physically acceptable).

29/06/2011 12:02:17		
<b>PHOTOVOLTAIC MPP300 - Pag 1/3</b>		
<b>PRp = 0.000</b>	<b>Pac = 3.73 kW</b>	
<b>Pdc = 5.54 kW</b>	<b><math>\eta_{ac}</math> = 0.67</b>	
<b><math>\eta_{dc}</math> = 0.00</b>		
<b>Irr = ... W/m<sup>2</sup></b>		
<b>Pnom = 5.000 kW</b>		
<b>Tc = ... °C</b>		
<b>Te = ... °C</b>		
RUN	TOT	DC AC



18. On SOLAR300N, press key **F3** to access the second screen which contains the values of the output DC parameters of the strings according to the number of DC inputs set (see §5.3.2.5).

In particular, in this screen:

Vdcx = dc voltage of string x.

Idcx = dc current of string x.

Pdcx = dc power of string x.

We recommend checking that the values of the electrical parameters (Vdc, Idc, Pdc) are consistent with the system being measured.

29/06/2011 12:04:53			
PHOTOVOLTAIC MPP300 - Pag 2/3			
Vdc1	=	223.6	V
Vdc2	=	223.8	V
Vdc3	=	223.5	V
Idc1	=	14.82	A
Idc2	=	14.94	A
Idc3	=	15.16	A
Pdc1	=	3.31	kW
Pdc2	=	3.34	kW
Pdc3	=	3.39	kW
RUN	TOT	DC	AC

Example of a DC screen for PV systems with 3 MPPTs

19. On SOLAR300N, press key **F4** to access the third screen which contains the values of the electrical parameters on the AC side of the inverter, consistently with the settings made (see settings in § 5.3.1 - single-phase, three-phase 4 wires).

In particular, in this screen:

Vacxy = ac voltage between Phase and Neutral (if single-phase) or between Phases x and y (if three-phase)

Iacx = ac current of phase x

Pacx = ac power of phase x

We recommend checking that the values of the electrical parameters (Vac, Iac, Pac) are consistent with the system being measured.

29/06/2011 12:07:53			
PHOTOVOLTAIC MPP300 - Pag 3/3			
Vac12	=	418.9	V
Vac23	=	386.8	V
Vac31	=	422.3	V
Iac1	=	16.58	A
Iac2	=	28.85	A
Iac3	=	15.42	A
Pac1	=	3.83	kW
Pac2	=	3.11	kW
Pac3	=	2.70	kW
RUN	TOT	DC	AC

Example of an AC screen for PV systems with three-phase output

20. Press the **F1** key (**GO/STOP** key for recording) to start the test or recording on a PV system on SOLAR300N. Consequently:

- The display of SOLAR300N shows the icon
- The display of SOLAR-02 shows the message "HOLD" and the time, expressed in seconds, remaining before the recording is started
- On MPP300, the STATUS LED turns on green (not flashing)

14/10/2011 17:46:23			
PHOTOVOLTAIC MPP300 - Pag 1/3			
PRp	=	0.000	Pac = 3.73 kW
Pdc	=	5.54 kW	ηac = 0.67
ηdc	=	0.00	
Irr	=	... W/m <sup>2</sup>	
Pnom	=	5.000 kW	
Tc	=	... °C	
Te	=	... °C	
RUN	TOT	DC	AC

21. Upon reaching the instant "00" after pressing the **F1** key, the test is started and the three units are synchronized with each other. In these conditions:

- The display of SOLAR300N shows the icon
- The display of SOLAR-02 shows the message "Recording..."
- On MPP300, the STATUS LED flashes green

14/10/2011 17:47:04			
PHOTOVOLTAIC MPP300 - Pag 1/3			
PRp	=	0.000	Pac = 3.73 kW
Pdc	=	5.54 kW	ηac = 0.67
ηdc	=	0.00	
Irr	=	... W/m <sup>2</sup>	
Pnom	=	5.000 kW	
Tc	=	... °C	
Te	=	... °C	
RUN	TOT	DC	AC

22. At any time while recording it will be possible to analyze its current status by selecting the button **Saved data management** in the **GENERAL MENU**. The following information will be shown:
- starting date and time of recording
  - the value set for the integration period
  - the number of periods elapsed from the beginning of the recording
  - the remaining memory capacity for recording

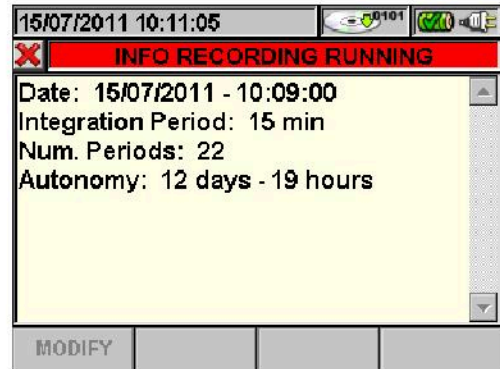

Press the **ESC** key to exit the screen



23. Now it is possible to bring the unit SOLAR-02 near the PV strings to measure irradiation and temperature by means of the relevant probes. When the distance between unit SOLAR-02 and MPP300 does not allow the RF connection, on the display of SOLAR-02 the symbol "📶" flashes for approx 30s and then disappears. Unit MPP300 steadily searches for the RF connection with unit SOLAR-02.
24. Position the reference cell onto the surface of the PV modules. Please refer to the relevant User Manual for a correct assembly.
25. Put the temperature sensor in contact with the rear side of the module and fasten it with some tape; prevent touching it with your fingers (as this could alter the measure).
26. Wait for a few seconds to allow the probes to reach a steady measure and then connect the irradiation probe to input **PYRA/CELL** and the temperature probe to input **TEMP** of unit SOLAR-02.
27. Wait for the message "**READY**" to appear on the display of SOLAR-02 to indicate that the unit has detected the data with solar irradiation > minimum threshold set (see § 5.3.3.3).
28. **With the message "READY" shown on the display, wait for approximately 1 minute in order to take a significant number of samples.**
29. Disconnect the irradiation and temperature probes from unit SOLAR-02 and bring the unit near unit MPP300. The two units must be near each other (max distance 1m).
30. Connect (if disconnected) the SOLAR300N unit to the MPP300 unit. The **MASTER** LED must always be flashing to indicate the connection between SOLAR300N and MPP300.
31. Press key ▼ on SOLAR-02 to activate the RF connection again. Consequently, the **REMOTE** LED on unit MPP300 will start flashing.



32. Press the **F1** key (FINISH) or **GO/STOP** key on the instrument to stop the test/recording on the instrument SOLAR300N and confirm with **ENTER** that you want to stop recording.
33. The display of SOLAR300N will show various messages indicating the different phases of data transfer to the main unit.
34. After the automatic phase of data transfer, the instrument:
  - Do not show any results if do not exist on the PV installation a “**stable irradiance**” condition more than the minimum irradiance threshold (see § 5.3.3.3)
  - Display the best performance values if during the recording, the Irradiance values reached the “**stable**” condition and its values were higher than the minimum irradiance threshold (see § 5.3.3.3)
35. Press **SAVE** to save the obtained results. Pressing the key will display the virtual keyboard for adding possible comments. Further pressing the **SAVE** key will archive the measure and the added comments and will go back to the initial screen for a new measurement.

15/07/2011 09:58:35		 	
<b>PHOTOVOLTAIC - OUTCOME</b>			
$PRp = 0.787$	$Pac = 3.71 \text{ kW}$		
$Pdc = 3.98 \text{ kW}$	$\eta ac = 0.93$		
$\eta dc = 0.85$			
<hr/>			
$Irr = 941 \text{ W/m}^2$			
$Pnom = 5.000 \text{ kW}$			
$Tc = 34.7 \text{ }^\circ\text{C}$			
$Te = -0.6 \text{ }^\circ\text{C}$			
TOT		DC	AC

**Example of a result combined with MPP300**



## 7.6. USING THE METER IN A SINGLE PHASE SYSTEM

**CAUTION**

- The maximum voltage between inputs D1, D2, A1, A2 and A3 is 1000V / CAT IV 600V to earth. Do not measure voltages exceeding the limits indicated in this manual. If these voltage limit values are exceeded, the user may be exposed to electrical shocks and the instrument could get damaged
- If possible, before connecting the meter to the electrical equipment to be tested turn the power supply off

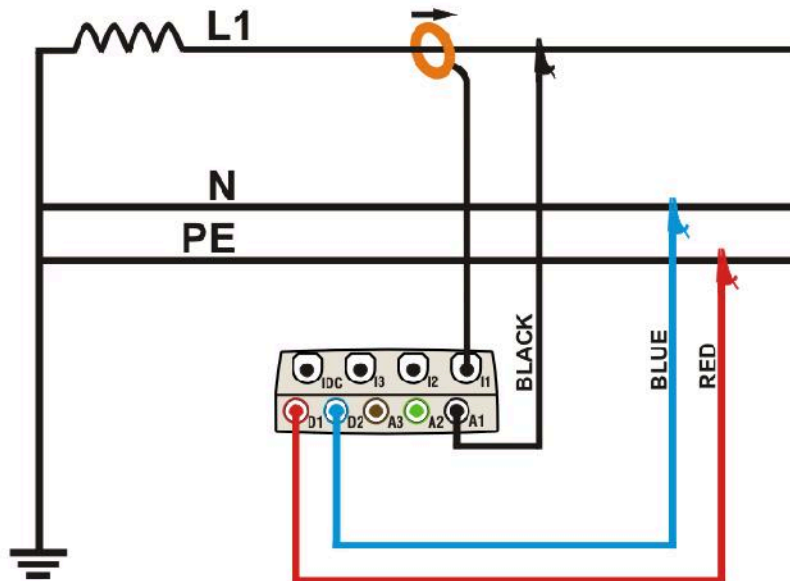

Fig. 165: Meter connection in a Single phase system

1. Check and modify the basic settings of meter if necessary (see § 5.3.1) Set **SINGLE** system option.
2. Connect voltage test leads on Phase, Neutral and Ground cables considering the colours as shown in Fig. 165).
3. Connect the transducer current clamp on L1 Phase cable as shown in Fig. 165) respecting the clamp's arrow direction indicating the current standard sequence from generator to load. **On Real Time Values' section screens always verify the positive value of Active Power and the power factor relative to load which should be normally inductive** before starting a recording. Reverse the clamp by 180 degrees on cables in case of negative readings.
4. Supply the electrical installation under test in case this was temporarily put out of service for meter connection. The values of parameters are shown by meter at display in Real Time Values section (see § 5.2.4.1).
5. Press **SAVE** key if an instantaneous sample of display values (Instant) should be saved (see § 5.7). Use **HOLD** function to stop the values at display if necessary.
6. Check all settings before start a recording (see § 5.4). Press **GO/STOP** key to enable and disable a recording on meter (see § 5.6).

## 7.7. USING THE METER IN A THREE PHASE 4 WIRE SYSTEM



### CAUTION

- The maximum voltage between inputs D1, D2, A1, A2 and A3 is 1000V / CAT IV 600V to earth. Do not measure voltages exceeding the limits indicated in this manual. If these voltage limit values are exceeded, the user may be exposed to electrical shocks and the instrument could get damaged
- If possible, before connecting the meter to the electrical equipment under test turn the power supply off

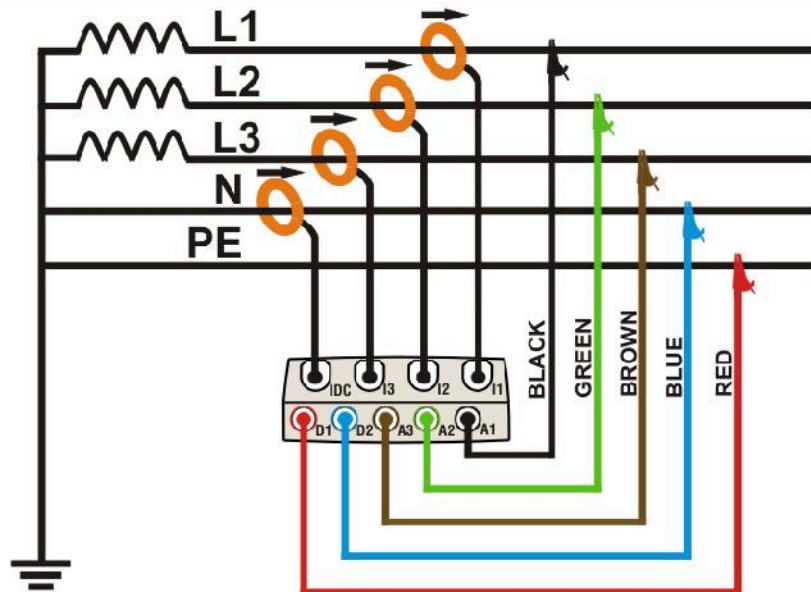

Fig. 166: Meter connection in a three phase 4-wire system

1. Check and modify the basic settings of meter if necessary (see § 5.3.1) Set **4WIRE** system option.
2. Connect voltage test leads on Phases L1, L2, L3, Neutral and Ground cables considering the colours as shown in Fig. 166. **Verify the result "123" at display relative to a correct phase sequence indication** (see § 5.2.4.1) and perform the corrections if necessary.
3. Connect the transducer current clamps on Phase L1, L2, L3 and Neutral N cables as shown in Fig. 166 respecting the clamp's arrow direction indicating the current standard sequence from generator to load. **On Real Time Values' section screens always verify the positive value of Active Power and the power factor relative to each load which should be normally inductive** before starting a recording. Reverse the clamp by 180 degrees on cables in case of negative readings.
4. Supply the electrical installation under test in case it was temporarily put out of service for meter connection. The values of parameters are shown by meter at display in Real Time Values' section (see § 5.2.4.1).
5. Press **SAVE** key if a instantaneous sample of display values (Instant) should be saved (see § 5.7). Use **HOLD** function to stop the values at display if necessary.
6. Check all settings before start a recording (see § 5.4). Press **GO/STOP** key to enable and disable a recording on meter (see § 5.6).



## 7.8. USING THE METER IN A THREE PHASE 3 WIRE SYSTEM



### CAUTION

- The maximum voltage between inputs D1, D2, A1, A2 and A3 is 1000V / CAT IV 600V to earth. Do not measure voltages exceeding the limits indicated in this manual. If these voltage limit values are exceeded, the user may be exposed to electrical shocks and the instrument could get damaged
- If possible, before connecting the meter to the electrical equipment under test turn the power supply off

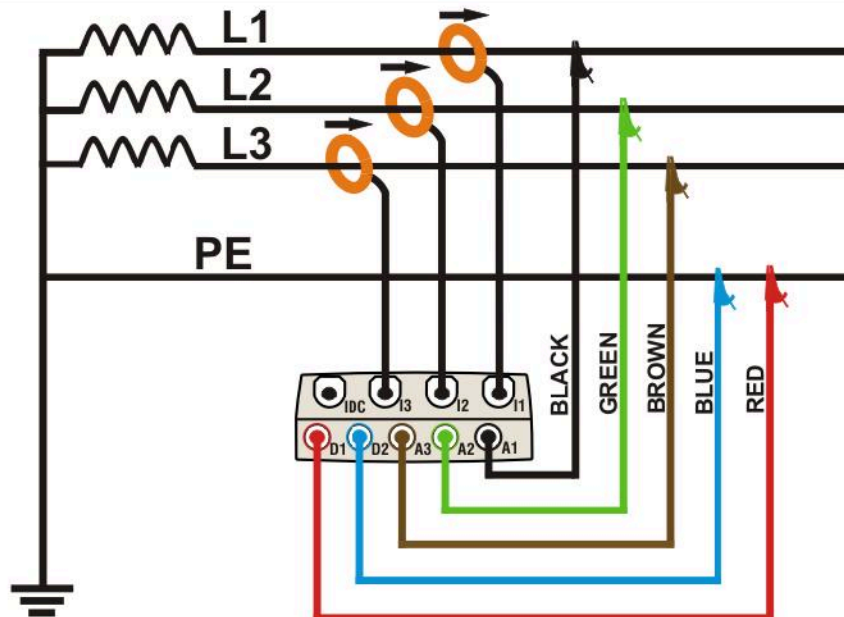

Fig. 167: Meter connection in a three phase 3-wire system

1. Check and modify the basic settings of meter if necessary (see § 5.3.1) Set **3WIRE** system option.
2. Connect voltage test leads on Phases L1, L2, L3, and Ground cables respecting the colours as shown in Fig. 167. **Verify the result "123" at display relative to a correct phase sequence indication** (see § 5.2.4.1) and perform the corrections if necessary.
3. Connect the transducer current clamps on Phase L1, L2, L3 cables as shown in Fig. 167 respecting the clamp's arrow direction indicating the current standard sequence from generator to load. **On Real Time Values' section screens always verify the positive value of Active Power and the power factor relative to load which should be normally inductive** before starting a recording. Reverse the clamp by 180 degrees on cables in case of negative readings.
4. Supply the electrical installation under test in case it was temporarily put out of service for meter connection. The values of parameters are shown by meter at display in Real Time Values' section (see § 5.2.4.1).
5. Press **SAVE** key if a instantaneous sample of display values (Instant) should be saved (see § 5.7). Use **HOLD** function to stopping the values at display if necessary.
6. Check all settings before start a recording (see § 5.4). Press **GO/STOP** key to enable and disable a recording on meter (see § 5.6).



## 7.9. USING OF METER IN A THREE PHASE 3 WIRE ARON SYSTEM



### CAUTION

- The maximum voltage between inputs D1, D2, A1, A2 and A3 is 1000V / CAT IV 600V to earth. Do not measure voltages exceeding the limits indicated in this manual. If these voltage limit values are exceeded, the user may be exposed to electrical shocks and the instrument could get damaged
- If possible, before connecting the meter to the electrical equipment under test turn the power supply off

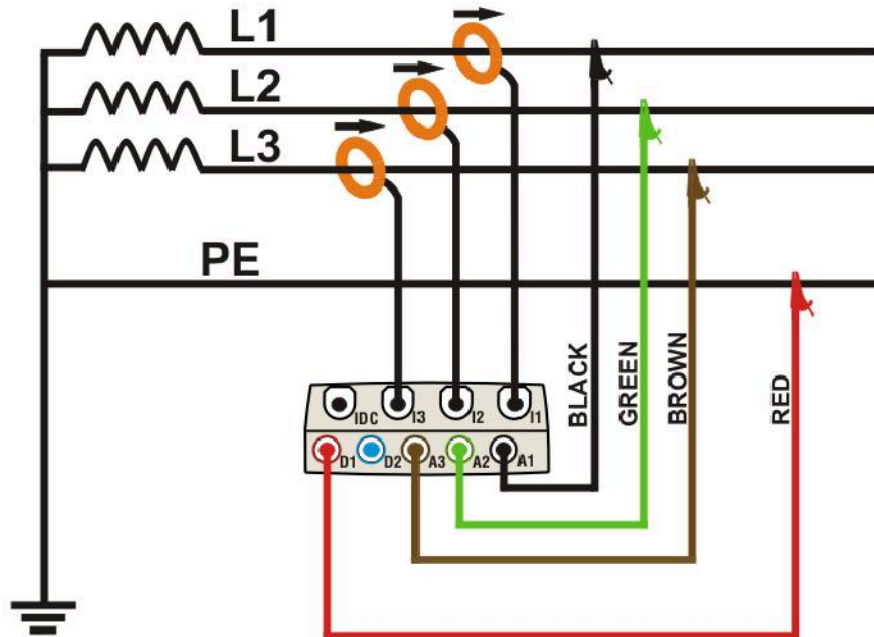

Fig. 168: Meter connection in a three phase 3-wire ARON system

1. Check and modify the basic settings of meter if necessary (see § 5.3.1) Set **ARON** system option.
2. Connect voltage test leads on Phases L1, L2, L3, and Ground cables considering the colours as shown in Fig. 168. **Verify the result "123" at display relative to a correct phase sequence indication** (see § 5.2.4.1) and perform the corrections if necessary.
3. Connect the transducer current clamps on Phase L1, L2, L3 cables as shown in Fig. 168 respecting the clamp's arrow direction indicating the current standard sequence from generator to load. **On Real Time Values' section screens (selecting a 3 wire system preliminarily) always verify the positive value of Active Power and the power factor relative to load which should be normally inductive** before starting a recording. Reverse the clamp by 180 degrees on cables in case of negative readings.
4. Supply the electrical installation under test in case it was temporarily put out of service for meter connection. The values of parameters are shown by meter at display in Real Time Values' section (see § 5.2.4.1).
5. Press **SAVE** key if a instantaneous sample of display values (Instant) should be saved (see § 5.7). Use **HOLD** function to stopping the values at display if necessary.
6. Check all settings before start a recording (see § 5.4). Press **GO/STOP** key to enable and disable a recording on meter (see § 5.6)

## 7.10. USING OF METER IN A 3-PHASE 4-WIRE 3PHL (USA SYSTEM)

**CAUTION**

The maximum voltage among D1, D2, A1, A2 and A3 inputs is 1000V / CAT IV 600V to ground. Do not measure voltages exceeding the limits prescribed by this manual. Should you exceed the voltage limits you could damage the instrument and/or its components or endanger your safety.

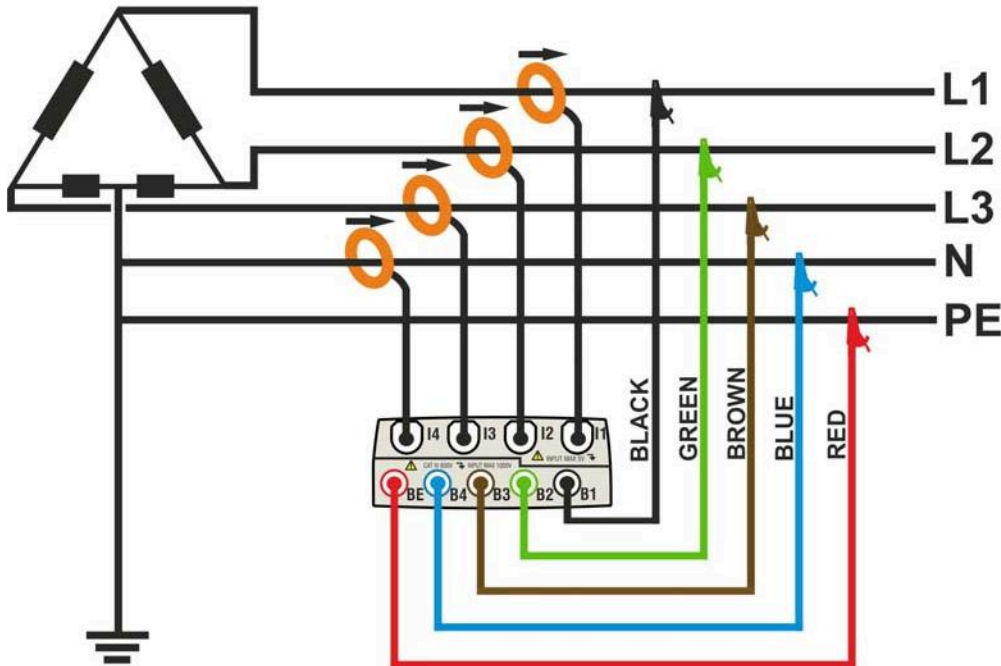

Fig. 169: Meter connection in a three phase 3PHL system

**CAUTION**

If possible, before connecting the meter to the electrical equipment under test turn the power supply off.

1. Check and modify the basic settings of meter if necessary (see § 5.3.1). Set **3PHL** system option.
2. Connect voltage test leads on Phases L1, L2, L3, N and PE cables considering the colours as shown in Fig. 169. **Verify the result "123" at display relative to a correct phase sequence indication** (see § 5.2.4.1) and perform the corrections if necessary.
3. Connect the transducer current clamps on Phase L1, L2, L3 and N cables as shown in Fig. 169 respecting the clamp's arrow direction indicating the current standard sequence from generator to load. **On Real Time Values' section screens (selecting a 3 wire system preliminarily) always verify the positive value of Active Power and the power factor relative to load which should be normally inductive** before starting a recording. Reverse the clamp by 180 degrees on cables in case of negative readings.
4. Supply the electrical installation under test in case it was temporarily put out of service for meter connection. The values of parameters are shown by meter at display in Real Time Values' section (see § 5.2.4.1).
5. Press **SAVE** key if a instantaneous sample of display values (Instant) should be saved (see § 5.7). Use **HOLD** function to stopping the values at display if necessary
6. Check all settings before start a recording (see § 5.4). Press **GO/STOP** key to enable and disable a recording on meter (see § 5.6)



## 7.11. USING OF METER IN A 3-PHASE 3-WIRE 3POD (USA SYSTEM)

**CAUTION**

The maximum voltage among D1, D2, A1, A2 and A3 inputs is 1000V / CAT IV 600V to ground. Do not measure voltages exceeding the limits prescribed by this manual. Should you exceed the voltage limits you could damage the instrument and/or its components or endanger your safety.

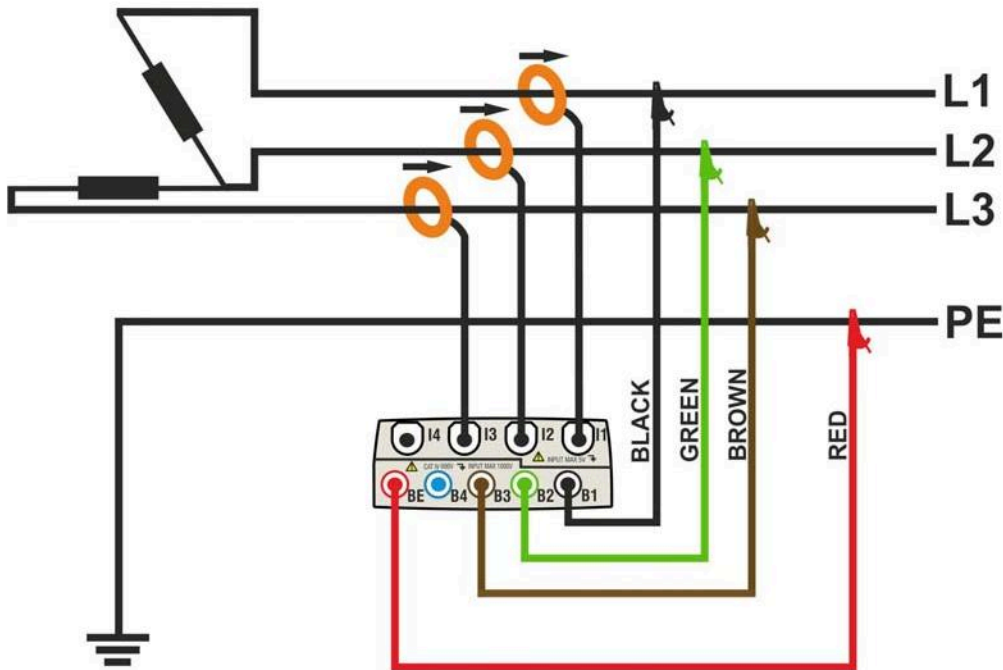

Fig. 170: Meter connection in a three phase 3POD system – ENG type

**CAUTION**

If possible, before connecting the meter to the electrical equipment under test turn the power supply off.

1. Check and modify the basic settings of meter if necessary (see § 5.3.1). Set **3P OD** system option.
2. Connect voltage test leads on Phases L1, L2, L3 and PE cables considering the colours as shown in Fig. 170. **Verify the result “123” at display relative to a correct phase sequence indication** (see § 5.2.4.1 ) and perform the corrections if necessary.
3. Connect the transducer current clamps on Phase L1, L2, L3 cables as shown in Fig. 170 respecting the clamp's arrow direction indicating the current standard sequence from generator to load. **On Real Time Values' section screens (selecting a 3 wire system preliminarily) always verify the positive value of Active Power and the power factor relative to load which should be normally inductive** before starting a recording. Reverse the clamp by 180 degrees on cables in case of negative readings.
4. Supply the electrical installation under test in case it was temporarily put out of service for meter connection. The values of parameters are shown by meter at display in Real Time Values' section (see § 5.2.4.1).
5. Press **SAVE** key if a instantaneous sample of display values (Instant) should be saved (see § 5.7). Use **HOLD** function to stopping the values at display if necessary
6. Check all settings before start a recording (see § 5.4). Press **GO/STOP** key to enable and disable a recording on meter (see § 5.6)



## 7.12. USING OF METER IN A 3 WIRE 3P2E (USA SYSTEM)

**CAUTION**

The maximum voltage among D1, D2, A1, A2 and A3 inputs is 1000V / CAT IV 600V to ground. Do not measure voltages exceeding the limits prescribed by this manual. Should you exceed the voltage limits you could damage the instrument and/or its components or endanger your safety.

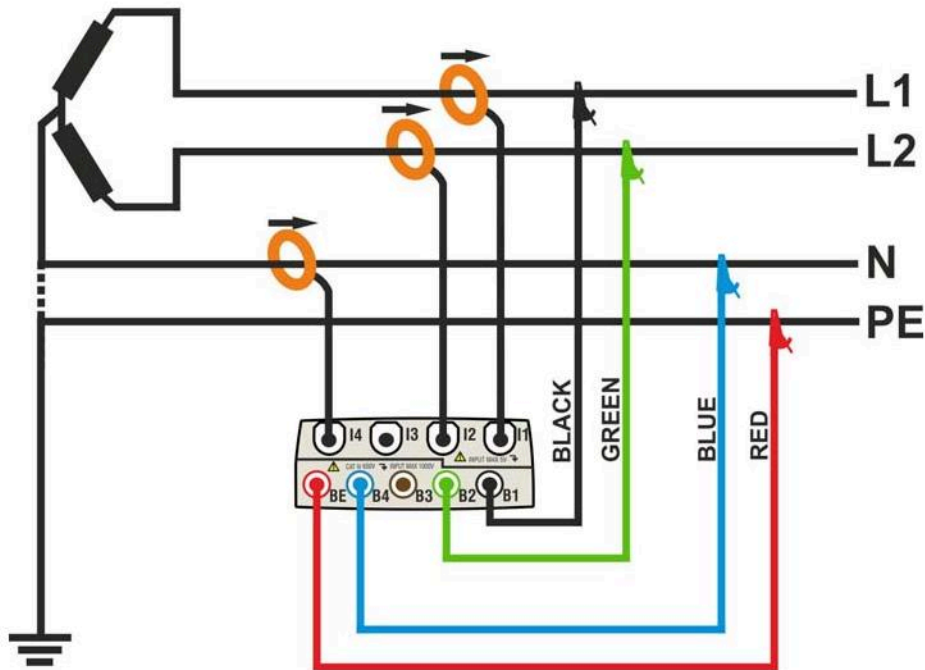

Fig. 171: Meter connection in a two phase 3-wire 3P2E system

**CAUTION**

If possible, before connecting the meter to the electrical equipment under test turn the power supply off.

1. Check and modify the basic settings of meter if necessary (see § 5.3.1). Set **3P 2E** system option.
2. Connect voltage test leads on Phases L1, L2, N and PE cables considering the colours as shown in Fig. 171
3. Connect the transducer current clamps on Phase L1, L2, N cables as shown in Fig. 171 respecting the clamp's arrow direction indicating the current standard sequence from generator to load. **On Real Time Values' section screens (selecting a 3 wire system preliminarily) always verify the positive value of Active Power and the power factor relative to load which should be normally inductive before starting a recording.** Reverse the clamp by 180 degrees on cables in case of negative readings.
4. Supply the electrical installation under test in case it was temporarily put out of service for meter connection. The values of parameters are shown by meter at display in Real Time Values' section (see § 5.2.4.1).
5. Press **SAVE** key if a instantaneous sample of display values (Instant) should be saved (see § 5.7). Use **HOLD** function to stopping the values at display if necessary
6. Check all settings before start a recording (see § 5.4). Press **GO/STOP** key to enable and disable a recording on meter (see § 5.6)

## 7.13. USING OF METER IN A 3 WIRE 3POY (USA SYSTEM)

**CAUTION**

The maximum voltage among D1, D2, A1, A2 and A3 inputs is 1000V / CAT IV 600V to ground. Do not measure voltages exceeding the limits prescribed by this manual. Should you exceed the voltage limits you could damage the instrument and/or its components or endanger your safety.

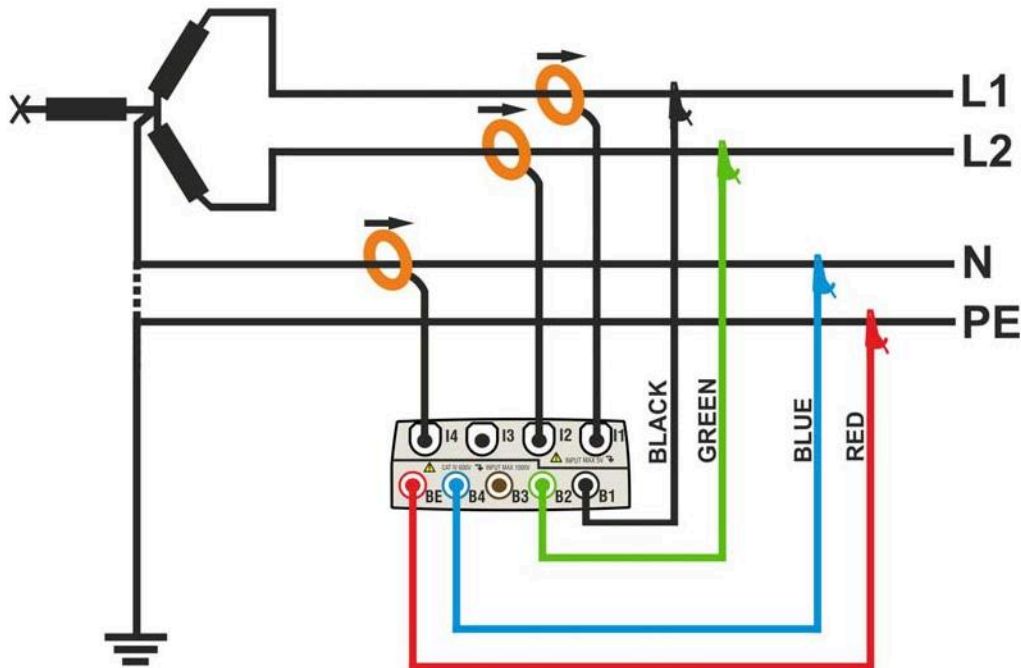

Fig. 172: Meter connection in a two phase 3-wire 3POY system

**CAUTION**

If possible, before connecting the meter to the electrical equipment under test turn the power supply off.

1. Check and modify the basic settings of meter if necessary (see § 5.3.1). Set **3P OY** system option.
2. Connect voltage test leads on Phases L1, L2, N and PE cables considering the colours as shown in Fig. 172
3. Connect the transducer current clamps on Phase L1, L2, N cables as shown in Fig. 172 respecting the clamp's arrow direction indicating the current standard sequence from generator to load. **On Real Time Values' section screens (selecting a 3 wire system preliminarily) always verify the positive value of Active Power and the power factor relative to load which should be normally inductive before starting a recording.** Reverse the clamp by 180 degrees on cables in case of negative readings.
4. Supply the electrical installation under test in case it was temporarily put out of service for meter connection. The values of parameters are shown by meter at display in Real Time Values' section (see § 5.2.4.1).
5. Press **SAVE** key if a instantaneous sample of display values (Instant) should be saved (see § 5.7). Use **HOLD** function to stopping the values at display if necessary
6. Check all settings before start a recording (see § 5.4). Press **GO/STOP** key to enable and disable a recording on meter (see § 5.6)



## 7.14. USING OF METER IN A 3 WIRE 1PH3W (USA SYSTEM)

**CAUTION**

The maximum voltage among D1, D2, A1, A2 and A3 inputs is 1000V / CAT IV 600V to ground. Do not measure voltages exceeding the limits prescribed by this manual. Should you exceed the voltage limits you could damage the instrument and/or its components or endanger your safety.

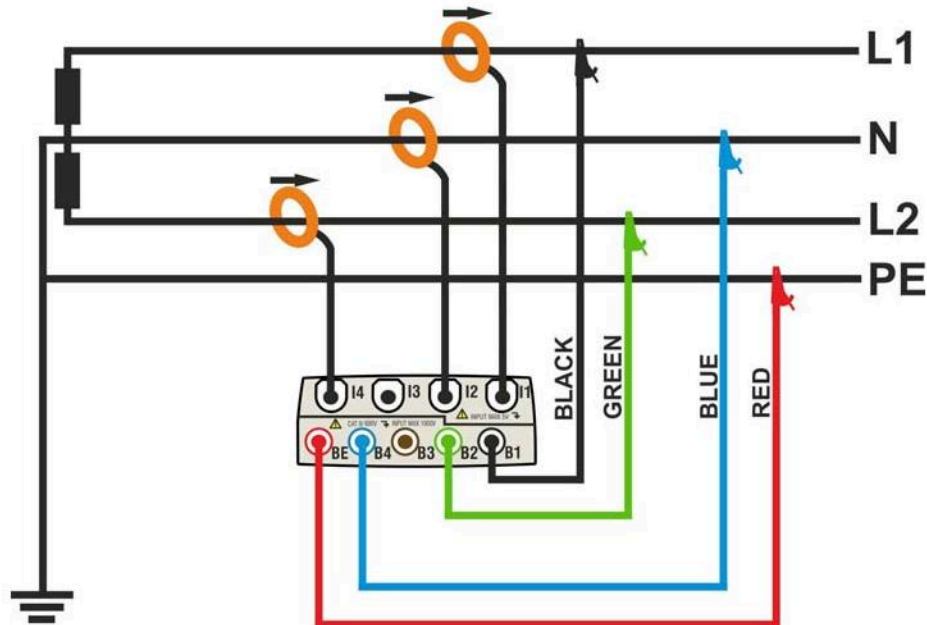

Fig. 173: Meter connection in a two phase 3-wire 1PH3W system

**CAUTION**

If possible, before connecting the meter to the electrical equipment under test turn the power supply off.

1. Check and modify the basic settings of meter if necessary (see § 5.3.1). Set **1PH3W** system option.
2. Connect voltage test leads on Phases L1, L2, N and PE cables considering the colours as shown in Fig. 173
3. Connect the transducer current clamps on Phase L1, L2, N cables as shown in Fig. 173 respecting the clamp's arrow direction indicating the current standard sequence from generator to load. **On Real Time Values' section screens (selecting a 3 wire system preliminarily) always verify the positive value of Active Power and the power factor relative to load which should be normally inductive before starting a recording.** Reverse the clamp by 180 degrees on cables in case of negative readings.
4. Supply the electrical installation under test in case it was temporarily put out of service for meter connection. The values of parameters are shown by meter at display in Real Time Values' section (see § 5.2.4.1).
5. Press **SAVE** key if a instantaneous sample of display values (Instant) should be saved (see § 5.7). Use **HOLD** function to stopping the values at display if necessary
6. Check all settings before start a recording (see § 5.4). Press **GO/STOP** key to enable and disable a recording on meter (see § 5.6)



## 8. MAINTENANCE

### 8.1. GENERAL

For their use and storage, follow the recommendations and instructions of this manual in order to avoid possible damages or dangers. Never use the instrument in environments with a high humidity or temperature. Do not expose the meter to direct sunlight. Always turn off the instrument after use.

### 8.2. SITUATIONS RELATIVE TO LED OF SOLAR-01 UNIT

Description	LED STATUS	LED REC	LED READY
SOLAR-01 switch OFF	OFF	OFF	OFF
SOLAR-01 switch ON	1 blink /1s	OFF	OFF
SOLAR-01 switch ON – Discharge batteries	1 blink /1s	1 blink /1s	1 blink /1s
SOLAR-01 switch ON – Memory full	1 blink /1s	1 blink /1s	1 blink /1s
SOLAR-01 switch ON – Pyranometer not connected	Fixed light	Blinking	OFF
SOLAR-01 Start measure wait for 00 seconds	1 blink /1s	1 blink /1s	OFF
SOLAR-01 Running measure – Radiation < threshold	OFF	1 blink /1s	OFF
SOLAR-01 Running measure – Radiation $\geq$ threshold	OFF	1 blink /1s	1 blink /1s

Table 15: List of situations relative to LED of SOLAR-01

#### 8.2.1. Replacement battery of SOLAR-01 and SOLAR-02

The remote unit SOLAR-01 is supplied by two AA 1.5 V alkaline batteries. The simultaneous flashing of the three LEDs READY STATUS and REC indicates that the battery is low. In this case, stop the measurements in progress, turn off the instrument by means of the appropriate ON/OFF key and disconnect the external probes. Remove the cover of the battery compartment and replace both batteries with two new batteries of the same type (alkaline AA 1.5 V). For battery replacement on remote unit SOLAR-02 make reference to the user manual.

### 8.3. SITUATIONS RELATIVE TO INTERNAL BATTERY OF INSTRUMENT

#### CAUTION



Do not open the battery cover in case for replacing of internal battery. This operation can be performed only by HT Technical Service.

The meter is powered by a rechargeable Li-ION battery with 3.7VDC output voltage which can be charged by using the supplied external adapter under any function mode. The battery-adapter packet defines several combinations which are shown through different icon in the top right display as follows:











Icon at display	Description
	Too low battery level. Perform a battery charging
	Residual battery charging at 25%
	Residual battery charging at 50%
	Residual battery charging at 75%
	Battery fully charged
	Only adapter connected. Battery disconnected
	Battery and adapter connected. Recharging battery
	Battery fully charged with adapter connected
	Battery charge unknown. Connect adapter
	Problem with battery. Contact HT Technical Service
	

Table 16: List of battery icons at display

#### 8.4. CLEANING

Use a soft dry cloth to clean the meter. Do not use never wet clothes, solvents, water etc.. and take particular care at TFT display.

#### 8.5. END OF LIFE



**CAUTION:** this symbol indicates that equipment, batteries and its accessories shall be subject to a separate collection and correct disposal.

## 9. TECHNICAL SPECIFICATIONS

### 9.1. TECHNICAL FEATURES

Accuracy is given as: [% reading + (number of digits)\*resolution] at 23°C ± 5°C ; <80%RH

#### DC Voltage – PV Systems

Range	Accuracy	Resolution	Input impedance
0.0 ÷ 1000.0V	±(0.5%rdg+2dgt)	0.1V	10MΩ

Voltage values < 20.0V are considered zero by meter

#### TRMS AC Phase-Neutral/Phase-Earth/Phase-Phase Voltage – Single/ Three-phase PV systems

Range	Accuracy	Resolution	Input impedance
0.0 ÷ 600.0V	±(0.5%rdg+2dgt)	0.1V	10MΩ
0.0÷1000.0V (P-P)			

Max crest factor = 2 ; Voltage values < 20.0V are considered zero by meter ; Meter is connectable with VT with ratio from 1 ÷ 3000

#### TRMS DC/AC Phase-Neutral/Phase-Earth/Phase-Phase Voltage – Single/ Three-phase NPV systems

Range	Accuracy	Resolution	Input impedance
0.0 ÷ 600.0V	±(0.5%rdg+2dgt)	0.1V	10MΩ
0.0÷1000.0V (P-P)			

Max crest factor = 2 ; Voltage values < 2.0V are considered zero by meter ; Meter is connectable with VT with ratio from 1 ÷ 3000

#### Voltage Anomalies – Phase-Neutral – NPV Single-phase / Three-phase systems with Neutral

Range	Voltage Accuracy	Time (50Hz) Accuracy	Voltage resolution	Time (50Hz) resolution
0.0 ÷ 600.0V	±(1.0%rdg+2dgt)	±10ms	0.2V	10ms

Maximum peak factor = 2. The voltage values < 2.0 V are zeroed.

The instrument can be connected to TV with Factor selectable between 1 ÷ 3000

Selectable threshold from ±1% to ±30%

#### Voltage Anomalies – Phase-Phase – NPV Three-phase Systems without Neutral

Range	Voltage Accuracy	Time (50Hz) Accuracy	Voltage resolution	Time (50Hz) resolution
0.0 ÷ 1000.0V	±(1.0%rdg+2dgt)	±10ms	0.2V	10ms

Maximum peak factor = 2. The voltage values < 2.0 V are zeroed.

The instrument can be connected to TV with Factor selectable between 1 ÷ 3000

Selectable threshold from ±1% to ±30%

#### Voltage Spikes – Phase-Ground - Single phase and Three phase systems

Range	Voltage Accuracy	Voltage Resolution	Time resolution (50Hz)	Detection time (50Hz)
-1000V ÷ 100V	±(2.0%rdg+60V)	1V	±10ms	78μs – 2.5ms (SLOW)
100V ÷ 1000V				
-6000V ÷ -100V	±(10%rdg+100V)	15V		5μs – 160μs (FAST)
100V ÷ 6000V				

Voltage detection threshold set from 100V ÷ 5000V

Maximum number of recorded events: 20000

#### DC Current (with external STD transducer clamp)

Range	Accuracy	Resolution	Input impedance	Overcharge protection
0.0÷1000.0mV	±(0.5%rdg+0.06%FS)	0.1mV	510kΩ	5V

FS = full scale clamp

Measure made by means of Clamp with Output = 1VDC when the clamp is under nominal current.

Current values < 0.1% of FS are zeroed.



**AC TRMS Current (with external STD transducer clamp)**

Range	Accuracy	Resolution	Input impedance	Overload protection
0.0 ÷ 1000.0mV	$\pm(0.5\%rdg+0.06\%FS)$	0.1mV	510k $\Omega$	5V

Measure performed with voltage output =1VAC with nominal current measured by clamp ; Max crest factor = 3  
Current values < 0.1% of full scale (FS) are considered zero by meter

**Current through FLEX transducer – NPV Systems – 300A range**

Range	Accuracy	Resolution	Input impedance	Overload protection
0.0 ÷ 49.9A	$\pm(0.5\%rdg+0.24\%FS)$	0.1A	510k $\Omega$	5V
50.0 ÷ 300.0A	$\pm(0.5\%rdg+0.06\%FS)$			

Measurements performed with HTFLEX33 flexible clamp. Max crest factor = 3  
Current values < 1A are considered zero by meter

**Current through FLEX transducer – NPV Systems – 3000A range**

Range (*)	Accuracy	Resolution	Input impedance	Overload protection
0.0 ÷ 3000.0A	$\pm(0.5\%rdg+0.06\%FS)$	0.1A	510k $\Omega$	5V

Measurements performed with HTFLEX33 flexible clamp. Max crest factor = 3  
Current values < 5A are considered zero by meter

**Inrush Current**

Range	Accuracy	Resolution	Time resolution (50Hz)	Time accuracy (50Hz)
Depending on clamp type	$\pm(1.0\%rdg+0.4\%FS)$	Depending on clamp type	10ms	$\pm 10ms$

Max crest factor = 3  
Maximum number of recorded events: 1000

**Power – DC (V<sub>mis</sub> > 150V)**

Parameter [W]	Full scale clamp FS	Range [W]	Resolution	Accuracy (*)
POWER	1A < FS ≤ 10A	0.000 – 9.999k	0.001k	$\pm(0.7\%rdg)$ @ (V <sub>mis</sub> >150V, I <sub>mis</sub> >10%FS) $\pm(0.7\%rdg + 3dgt)$ @ (V <sub>mis</sub> < 150V or I <sub>mis</sub> < 10%FS)
	10A < FS ≤ 100A	0.00 – 99.99k	0.01k	
	100A < FS ≤ 3000A	0.1 – 999.9k	0.1k	

(\*) For STD clamp ; V<sub>mis</sub> = Voltage at which Power is measured

**Power – Single-phase and Three-phase systems – 50/60Hz**

Parameter [W, VAr, VA]	FS clamp	Range [W, VAr, VA]	Resolution [W, VAr, VA]	Accuracy (*)
Active power Reactive power Apparent power	FS ≤ 1A	0 – 999.9k	0.1 – 0.001k	$\pm(0.7\%rdg)$ @ (Pf=1, V <sub>mis</sub> >200V, I <sub>mis</sub> >10%FS) $\pm(0.7\%rdg)$ @ (Pf=1, V <sub>mis</sub> >200V, I <sub>mis</sub> > 10A if FS=200A) $\pm(0.7\%rdg + 3dgt)$ @ (Pf<1 or V <sub>mis</sub> < 200V or I <sub>mis</sub> < 10%FS or I <sub>mis</sub> < 10A if FS=200A)
	1A < FS ≤ 10A	0.000 – 99.99k	0.001k – 0.01k	
	10A < FS < 200A	0.00 – 999.9k	0.01k – 0.1k	
	200A < FS ≤ 3000A	0.0 – 9.999M	0.1k – 0.01M	

(\*) For STD clamp ; V<sub>mis</sub> = Voltage at which Power is measured

**Energy – Single-phase and Three-phase systems – 50/60Hz**

Parameter [Wh,VArh,VAh]	FS clamp	Range [Wh,VArh,VAh]	Resolution [Wh,VArh,VAh]	Accuracy (*)
Active energy Reactive energy Apparent energy	FS ≤ 1A	0 – 999.9k	0.1 – 0.001k	±(0.7%rdg) @ (Pf=1, Vmis>200V, Imis>10%FS) ±(0.7%rdg) @ (Pf=1, Vmis > 200V, Imis>10A if FS=200A) ±(0.7%rdg +3dgt) @ (Pf<1 or Vmis < 200V or Imis < 10%FS or Imis <10A if FS=200A)
	1A< FS ≤ 10A	0.000 – 99.99k	0.001k – 0.01k	
	10A< FS < 200A	0.00 – 999.9k	0.01k – 0.1k	
	200A< FS ≤ 3000A	0.0 – 9.999M	0.1k – 0.01M	

(\*) For STD clamp ; Vmis = Voltage at which Power is measured

**Power Factor (Cosφ) – Single phase / Three phase systems**

Range	Accuracy (°)	Resolution (°)
0.20 ÷ 1.00	1.0 ÷ 0.6	0.01

**Voltage / Current harmonics**

Range	Accuracy(*)	Resolution
DC ÷ 25 <sup>a</sup>	±(5.0%rdg+5digits)	0.1V / 0.1A
26 <sup>a</sup> ÷ 33 <sup>a</sup>		
34 <sup>a</sup> ÷ 49 <sup>a</sup>		

(\*) Accuracy to add at correspondent TRMS paramters

**Frequency**

Range	Accuracy	Resolution
42.5 ÷ 69.0Hz	±(0.2%rdg+1dgt)	0.1Hz

**Flicker – Single phase / Three phase systems**

Parameter	Range	Accuracy	Resolution
Pst1', Pst	0.0 ÷ 10.0	compliance to EN50160	0.1
Plt			

**Irradiation measurement (by means of remote unit SOLAR-01 and input PYRA)**

Range	Accuracy	Resolution	Overcharge protection
0.00 ÷ 12.00mV	±(1.0%rdg+5dgt)	0.01mV	5V
0.00 ÷ 40.00mV		0.02mV	

**Temperature measurement (by means of remot unit SOLAR-01 and input TEMP with PT1000 probe)**

Range	Accuracy	Resolution	Overcharge protection
0 ÷ 100°C	±(1%rdg+2dgt)	1°C	5V

## 9.2. GENERAL FEATURES

### Real time values

General network parameters:	Voltages, Currents, Powers, Energies, Cosφ, PF Flicker, Unbalance, THD%, Harmonics
Signals waveforms:	Voltages, Currents, harmonics histograms
Vectorial diagrams:	Voltages, Currents

### Recordings

Parameters:	each general parameters + energies
Number of selectable parameter:	max 251
Integration period:	1, 2, 5, 10, 30sec, 1, 2, 5, 10, 15, 30, 60min
Recording time:	>3 months with 251 parameters@15min
Recording time SOLAR-xx unit:	approx 1.5 hours of test (@ IP = 5s)

### Display

Characteristics:	Graphic TFT with backlight, ¼" VGA (320x240pxls)
Touch screen:	yes
Number of colours:	65536
Brightness adjustment:	programmable

### Operative system and memory

Operative system:	Windows CE
Internal memory:	about 15Mbytes (about 32Mbytes with Compact Flash)
PC interface:	USB

### Power supply

Internal power supply:	Li-ION, 3.7V rechargeable battery, autonomy >6 hours
Internal power supply SOLAR-xx:	2x1.5V batteries tyep AA LR06, ca 1month autonomy
Instrument external power supply:	AC/DC adapter 100÷240VAC / 50-60Hz – 5VDC
Auto power OFF:	after 5min of no use (without external adapter)

### Mechanical characteristics

Size:	235(L)x165(W)x75(H) ; 9(L) x 6(W) x 3(H) inch
Weight (included battery):	1.0kg (35 ounces)

### Reference standards

Safety of meter:	IEC/EN61010-1
Technical literature:	IEC/EN61187
Safety standard accessories:	IEC/EN61010-031, IEC/EN61010-2-032
Insulation:	Double insulation
Pollution degree:	2
Max altitude:	2000m (6562 ft) (*)



#### CAUTION

##### (\*) Information about the use of meter at altitude from 2000 to 5000m

As for voltage inputs A1, A2, A3, D1, D2 the instrument is to be considered downgraded to overvoltage category CAT III 600V to ground, max 1000V between inputs or CAT IV 300V to ground, max 600V between inputs. Markings and symbols indicated on the instrument are to be considered valid when using it at altitude lower than 2000m

Overvoltage category (@ 2000m):	CAT IV 600V to Ground, max 1000V between inputs
Power Quality:	EN50160
Quality of electrical power:	IEC/EN61000-4-30 class B
Flicker :	IEC/EN61000-4-15, EN50160
Unbalance:	IEC/EN61000-4-7, EN50160

## 9.3. ENVIRONMENT

Reference calibration temperature:	23° ± 5°C ; (73°F ± 41°F)
Working temperature:	0 ÷ 40°C ; (32°F ÷ 104°F)
Relative humidity:	<80%HR
Storage temperature:	-10 ÷ 60°C ; (14°F ÷ 140°F)
Storage relative humidity to:	<80%HR

**This instrument complies with the prescriptions of the European directive on low voltage 2014/35/EU (LVD) and EMC 2014/30/EU**

**This instrument satisfies the requirements of 2011/65/EU (RoHS) directive and 2012/19/EU (WEEE) directive**

## 9.4. ACCESSORIES

Use only the optional accessories indicated in the enclosed packing list



## 10. APPENDIX – THEORETICAL OUTLINES

### 10.1. TESTING PV SYSTEMS

According to the requirements of the laws in force, the result of the test depends on settings about Temperature effects compensation and **PRp** calculations :

Corr.Type	Tcel value	PRp calculation	Guideline
<b>Tmod</b>	Tcel = PV Module Temp. <b>measured</b>	$PRp = \frac{P_{ca}}{\left[ R_{f2} \times \frac{G_p}{G_{STC}} \times P_n \right]}$	CEI 82-25 (Italian Guideline)
<b>Tamb or Tenv</b>	Tcel = PV module Temp. <b>calculated</b> $T_{cel} = T_{amb} + (NOCT - 20) \times \frac{G_p}{800}$		
<b>nDC</b>	Tcel = PV Module Temp. <b>measured</b>	$PRp = \frac{G_{STC}}{G_p} \times \left[ 1 + \frac{ \gamma }{100} \times (T_{cel} - 25) \right] \times \frac{P_{ca}}{P_n}$	...

where:

Symbol	Description	Meas. unit
$G_p$	Irradiance on PV module surface	[W/m <sup>2</sup> ]
$G_{STC}$	Standard Irradiance = 1000	[W/m <sup>2</sup> ]
$P_n$	Nominal Power = sum of all power module (Pmax ) included in the part of PV plant under test	[kW]
$P_{ca}$	AC Active Power measured	[kW]
$R_{f2} = \begin{cases} 1 & \text{(if } T_{cel} \leq 40^\circ\text{C)} \\ 1 - (T_{cel} - 40) \times \frac{ \gamma }{100} & \text{(if } T_{cel} > 40^\circ\text{C)} \end{cases}$	Thermal Corrective factor	
$ \gamma $	Absolute value of Pmax thermal coefficient	[%/°C]
NOCT	Normal Operating Cell Temperature (@ 800W/m <sup>2</sup> , 20°C, AM=1.5, vel. Aria =1m/s).	[%/°C]

Previous relationship are valid if **Irradiance > Min Irradiance value** (see user's manual of the MASTER instrument) and the Irradiance values are "steady": if  $IP \leq 1\text{min} \rightarrow (Irr\ max - Irr\ min) < 20\text{W/m}^2$

The final OUTCOME can be:

- **Non-displayable:** if the obtained values are inconsistent (e.g. PRp >1.15) or if irradiation has never reached a **steady** value > minimum threshold set.
- The maximum performance point (PRp) of the system

The highest performance (maximum value of PRp) is detected according with previous relationships.

## 10.2. RECORDING ON PV SYSTEMS

As regards the recordings which can be carried out by the instrument on PV installations by pressing the **GO/STOP** key, the same relationships described in § 10.1 above apply, with the only difference lying in the condition of “steady irradiation” for the samples detected with PI defined by the user. In particular, the following conditions must exist in order to obtain a positive result:

- The AVERAGE value of the measured irradiation is > minimum threshold set (see § 5.3.3.3)
- For recordings with **PI < 1min** the difference between the maximum and minimum measured irradiation values is < 20W/m<sup>2</sup>
- For recordings with **PI > 1min** the AVERAGE value of the measured irradiation is always > minimum threshold set (see § 5.3.3.3)

### 10.3. NOTES ON MPPT (MAXIMUM POWER POINT TRACKER)

Solar irradiation on a surface such as the surface of a photovoltaic system has extremely variable characteristics, since it depends on the position of the sun with respect to the surface and on atmospheric conditions (typically, on the presence of clouds). A photovoltaic module presents, for different solar irradiation values, and for different temperature values, a range of characteristic curves of the type shown in the following figure. In particular, the figure shows three I-V curves (in bold) which correspond to three values (1000, 800, 600W/m<sup>2</sup>) of solar irradiation.

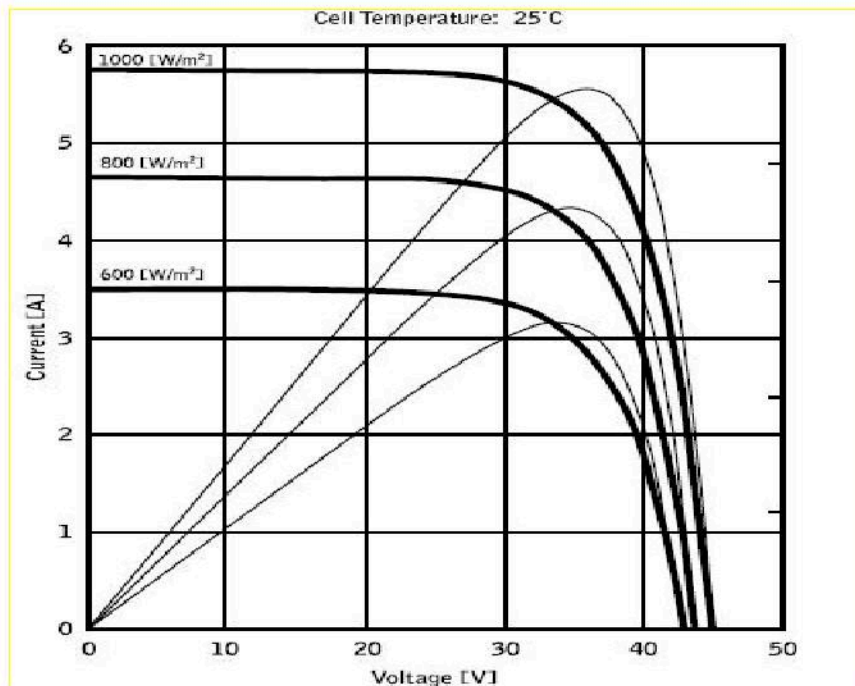

On each characteristic curve there is one single point in which the power transfer towards a hypothetical charge supplied by the photovoltaic module is maximized. The maximum power point corresponds to the voltage-current pair for which the product  $V \cdot I$  is maximum, where  $V$  is the value of voltage at the module's terminals and  $I$  is the current which runs in the circuit obtained by closing the module on a hypothetical charge.

With reference to the figure above, the product  $V \cdot I$  is represented, for the three solar irradiation values mentioned above, through the three curves in thinner lines.

The figure shows that, as stated above, these curves only have one single maximum point. For example, for 1000W/m<sup>2</sup>, the maximum power point corresponds to a voltage value of approx. 36V and to a current value of approx. 5.5A.

Obviously, if the power provided by the system is maximized, it is possible to make the most of the system, both in case the system is connected to mains, and in case it is stand-alone.

MPPT is an inbuilt device in the inverters. It typically reads the voltage and current values at any instant, calculates their product (i.e. the power in Watts) and, by causing small variations in the conversion parameters (duty cycle), it is capable of determining, by comparison, if the photovoltaic module is working in maximum power conditions or not. According to the result, it operates again on the circuit in order to bring the system to an optimal condition.



The reason why MPPTs are used is simple: a photovoltaic system without MPPTs may operate anyway; however, with the same solar irradiation, it provides less energy.

There are inverters with 1, 2 or also 3 inbuilt MPPTs available on the market. Typically, the inverters with more than one MPPT are used in systems where:

- The different photovoltaic systems it consists of “forcibly” have different inclinations or directions. In this way, each single MPPT manages its own photovoltaic field, maximizing its performance for the corresponding irradiation and temperature characteristics (without being influenced by the other photovoltaic fields).
- A greater service continuity is sought. With more MPPTs it is possible to put one single photovoltaic field out of service, while the others continue producing energy towards the remaining MPPTs.

#### 10.4. VOLTAGE ANOMALIES

The meter is capable of recording all those TRMS values as voltage anomalies, calculated every 10ms, beyond the percentage thresholds of Voltage Reference (Vref) set during the programming from  $\pm 1\%$  to  $\pm 30\%$  in steps of 1%. These limits remain unchanged throughout the recording period.

The reference are set to:

Nominal Voltage Phase to Neutral: for Single Phase and 4 wires three phase system  
Nominal Voltage Phase to Phase: for 3 wires three phase system

##### **Example1: Three Phase System 3 wires.**

Vref = 400V, LIM+= 6%, LIM-=10% =>

High Lim =  $400 \times (1+6/100) = 424,0V$

Low Lim =  $400 \times (1-10/100) = 360$

##### **Example2: Three Phase System 4 wires.**

Vref = 230V, LIM+= 6%, LIM-=10% =>

High Lim =  $230 \times (1+6/100) = 243,08V$

Low Lim =  $230 \times (1-10/100) = 207,0V$

For each voltage anomaly the instrument records:

- The number corresponding to the phase where the anomaly occurred.
- The “direction” of the anomaly: “UP” and “DN” identify voltage drops (sag) and peaks (swell) respectively.
- The date and time of the event beginning in the form day, month, year, hour, minutes, seconds, hundredths of second.
- The duration of the event, in seconds with a resolution of 10ms.
- The minimum (or maximum) value of voltage during the event.

## 10.5. VOLTAGE AND CURRENT HARMONICS

### 10.5.1. Theory

Any periodical no-sine wave can be represented as a sum of sinusoidal waves having each a frequency that corresponds to an entire multiple of the fundamental, according to the relation:

$$v(t) = V_0 + \sum_{k=1}^{\infty} V_k \sin(\omega_k t + \varphi_k) \quad (1)$$

where:

$V_0$  = Average value of  $v(t)$

$V_1$  = Amplitude of the fundamental of  $v(t)$

$V_k$  = Amplitude of the  $k^{\text{th}}$  harmonic of  $v(t)$

In the mains voltage, the fundamental has a frequency of 50 Hz, the second harmonic has a frequency of 100 Hz, the third harmonic has a frequency of 150 Hz and so on. Harmonic distortion is a constant problem and should not be confused with short events such as sags, swells or fluctuations.

It can be noted that in (1) the index of the sigma is from 1 to the infinite. What happens in reality is that a signal does not have an unlimited number of harmonics: a number always exists after which the harmonics value is negligible.

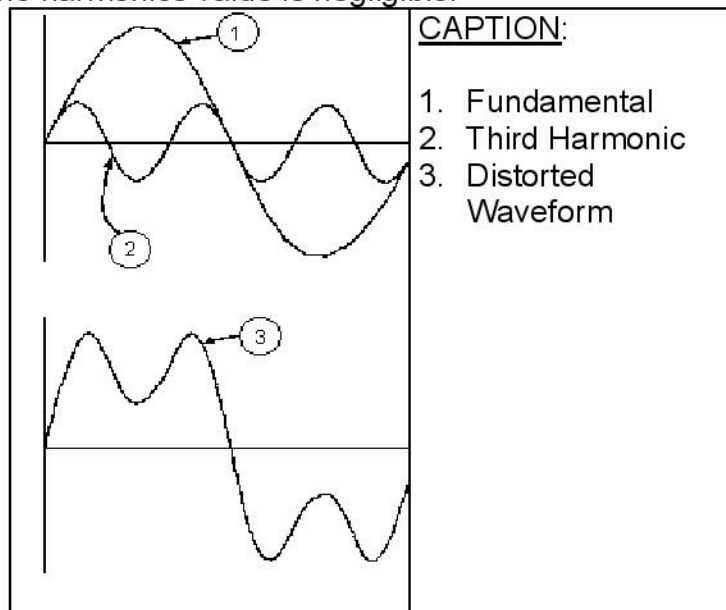

**Effect of the sum of 2 multiple frequencies.**

The EN50160 standard recommends to stop the index in the expression (1) corresponding to the 40<sup>th</sup> harmonic. A fundamental element to detect the presence of harmonics is THD defined as:

$$THDV\% = \frac{\sqrt{\sum_{h=2}^{40} V_h^2}}{V_1} \times 100$$

This index takes all the harmonics into account. The higher it is, the more distorted the waveform results.



### 10.5.2. Limit values for harmonic voltage

EN50160 standard fixes the limits for the harmonic voltages, which can be introduced into the network by the power supplier. In normal conditions, during any period in a week, 95% of the RMS values of each harmonic voltage, mediated on 10 minutes, shall be lower than or equal to the values stated in the following table. The total harmonic distortion (THD) of the supply voltage (including all the harmonics up to 40<sup>th</sup> order) must be lower than or equal to 8%.

ODD HARMONICS				EVEN HARMONICS	
Not multiple of 3		Multiple of 3		Order h	Relative voltage %Max
Order h	Relative voltage % Max	Order h	Relative voltage % Max		
5	6	3	5	2	2
7	5	9	1,5	4	1
11	3,5	15	0,5	6..24	0,5
13	3	21	0,5		
17	2				
19	1,5				
23	1,5				
25	1,5				

Table 17: Reference values for harmonics voltage in compliance to EN50160

These limits, theoretically applicable only for the suppliers of electric energy, provide anyway a series of reference values within which the harmonics introduced into the network by the users must be contained

### 10.5.3. Presence of harmonics: causes

Any apparatus that alters the sine wave or uses only a part of such a wave causes distortions to the sine wave and therefore harmonics.

All current signals result in some way virtually distorted. The most common situation is the harmonic distortion caused by no-linear loads such as electric household appliances, personal computers or speed control units for motors. Harmonic distortion causes significant currents at frequencies that are odd multiples of the fundamental frequency. Harmonic currents affect considerably the neutral wire of electric installations.

In most countries, the mains power is three-phase 50/60Hz with a delta primary and star secondary transformers. The secondary generally provides 230V AC from phase to neutral and 400V AC from phase to phase. Balancing the loads on each phase has always represented an headache for electric system designers.

Tracing back to ten years ago, in a well balanced system, the vectorial sum of the currents in the neutral was zero or quite low (in view of the difficulty to get a perfect balance). The devices were incandescent lights, small motors and other devices that presented linear loads. The result was an essentially sinusoidal current in each phase and a low current on the neutral at a frequency of 50/60Hz.

“Modern” devices such as TV sets, fluorescent lights, video machines and microwave ovens normally draw current for only a fraction of each cycle thus causing non-linear loads and subsequent non-linear currents. All this generates odd harmonics of the 50/60Hz line frequency. For this reason, the current in the transformers of the distribution boxes contains only a 50Hz (or 60Hz) component but also a 150Hz (or 180Hz) component, a 50Hz (or 300Hz) component and other significant components of harmonic up to 750Hz (or 900Hz) and higher.

The vectorial sum of the currents in a well balanced system that feeds no-linear loads may still be quite low. However, the sum does not eliminate all current harmonics. The odd multiples of the third harmonic (called “TRIPLENS”) are added together in the neutral and can cause overheating even with balanced loads.



#### 10.5.4. Presence of harmonics: consequences

In general, even harmonics, i.e. the 2<sup>nd</sup>, 4<sup>th</sup> etc., do not cause problems. Triple harmonics, odd multiples of three, are added on the neutral (instead of deleting each other) thus creating a condition of overheating of the wire which is extremely dangerous.

Designers should take into consideration the three issues given below when designing a power distribution system that will contain harmonic current:

- The neutral wire must be of sufficient gauge.
- The distribution transformer must have an additional cooling system to continue operating at its rated capacity when not suited to the harmonics. This is necessary because the harmonic current in the neutral wire of the secondary circuit circulates in the delta-connected primary circuit. This circulating harmonic current heats up the transformer.
- Phase harmonic currents are reflected on the primary circuit and continue back to the power source. This can cause distortion of the voltage wave so that any power factor correction capacitors on the line can be easily overloaded.

The 5<sup>th</sup> and the 11<sup>th</sup> harmonic contrast the current flow through the motors making its operation harder and shortening their average life.

In general, the higher the ordinal harmonic number, the smaller its energy is and therefore its impact on the devices (except for transformers).

## 10.6. INRUSH CURRENTS

The SOLAR300N meter permits the real time detection of inrush current events, typical of start-up of electrical machines and also for other industrial applications (e.g. troubleshooting problem regarding loads switching, correct calculation of protection devices, oscillating currents, etc...) as shown in the following pictures:

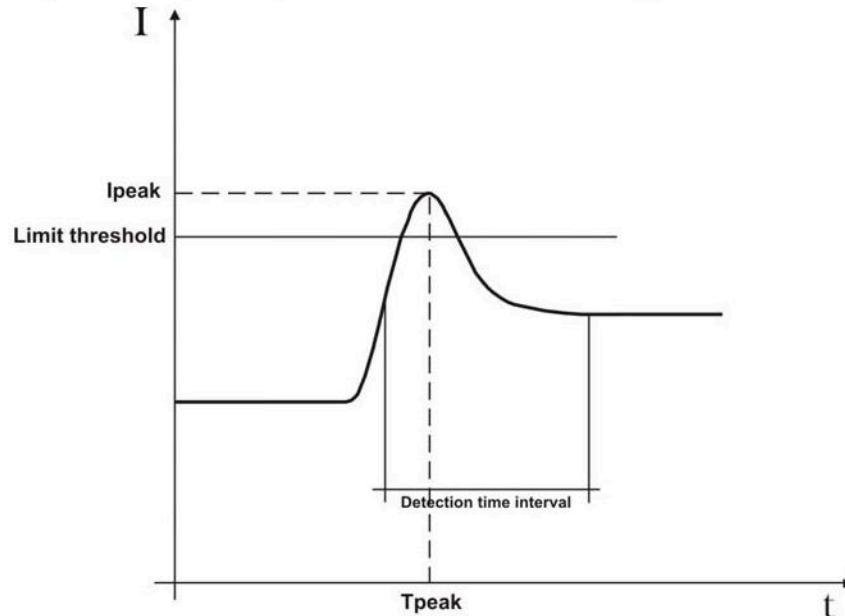

Fig. 174: Parameters of standard inrush current event

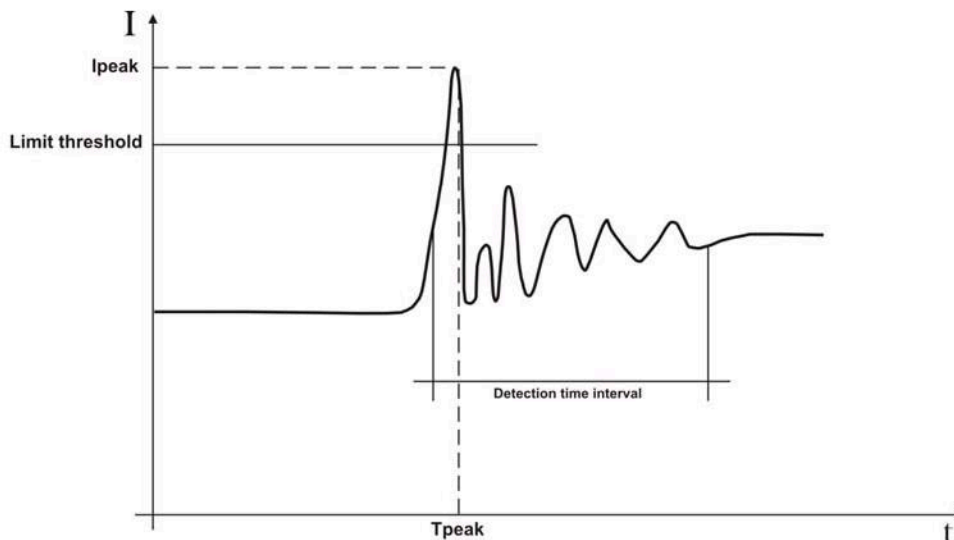

Fig. 175: Parameters of oscillating inrush current event

The meter detect and recording as inrush current all the events where the phase currents TRMS values are over a set limit threshold. The maximum number of recorded events is fixed to **1000**.

During setting operation before recording start the user can be modify the below parameters:

- **Current limit threshold:** Current value of detection and recording of the event. The maximum set value of this parameter is always equal to the full scale of used transducer clamps.
- **Detectable modes :** The below modes are available and selectable:

**FIX:** The meter detect and recording a event each time the TRMS value of current, calculated on each half period (10ms @ 50Hz, 8.3ms @ 60Hz), it's over the limit threshold defined by user. **A new event is detected by meter always if the current value decrease under the set limit threshold.**

**VAR:** The meter detect and recording a event each time the TRMS value of current, calculated on each half period (10ms @ 50Hz, 8.3ms @ 60Hz), it's over of the previous TRMS value (calculated in previous half period) of a difference defined by the limit threshold defined by user.

- **Detectable time interval:** As soon as the meter detect a event, it's recording 100 TRMS value of current and 100 TRMS value of the correspondent voltage within the detectable time interval set by user. The available values are **1s, 2s, 3s, 4s.**

The SOLAR300N meter shows at display the number of detectable events during the recording. The analysis of results is only possible downloading the saved data to PC and using the standard TopView software. In particular the below parameters are shown:

- **Table of recorded events** (phase where the event is occurred, date/time when the event is occurred, maximum value between TRMS values calculated in a half period during the detectable time interval, value of last sample at the end of the detectable time interval).
- **Graphical window of recorded events** (graphic of saved 100 TRMS values of current and correspondent voltage during the detectable time interval for each row of the table of recorded events).

**For any detail about saved data please refer to TopView HELP ON LINE feature.**

### 10.7. FLICKER

Considering the theoretical definition, **Flicker** is due to an abnormal variations of voltage supply, in particular relative to its RMS value as the luminescence of a traditional light is a direct consequence. This effect should be monitoring in compliance with reference EN50160 standard.

Main causes of this disturbance are typically due to discontinuous switching of big loads which are connected to electrical network (e.g. furnaces, foundries, arc welders for industrial use).

Electrical suppliers should satisfy severe regulations regarding this kind of disturbance. With suitable meters, called *flicker meters*, it's possible to get a ratio between a distort signal and an ideal signal and perform a statistics analysis relative to calculation of the following parameters whose values **must be always <1**:

**Pst** = Short term severity of Flicker calculated in an interval of 10 minutes.

**Plt** = Long term severity of Flicker calculated considering a sequence of 12 values of Pst in an interval of two hours according to the following formula:

$$P_{lt} = \sqrt[3]{\sum_{i=1}^{12} \frac{P_{sti}^3}{12}}$$



## 10.8. SUPPLY VOLTAGE UNBALANCE

In normal conditions the supply voltage and the final loads are perfectly balanced. Unbalances are possible in trouble situations (low insulation) and/or phase circuits interruptions. Moreover, in single phase systems, the balance can be only statistic.

In order to design a correct protection installation a thorough study of anomalous conditions on three phase systems was performed. To better understand the meaning of an installation's parameter the theory of symmetric components is fundamental.

From the theory is always true that any tern of vectors can be decomposed in three kind of tern: the direct (positive) symmetric tern, the reversed (negative) symmetric tern and the omopolar (zero) tern as shown in below picture:

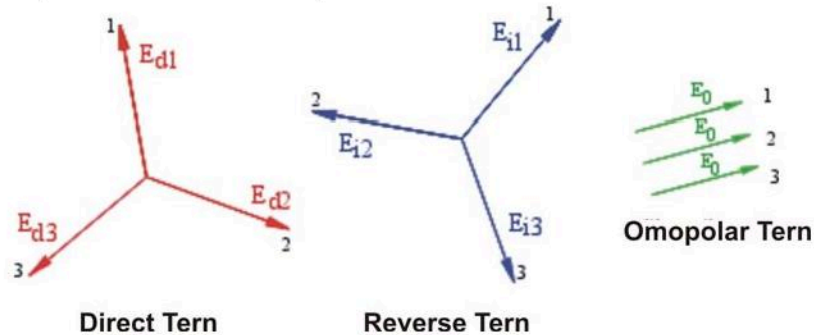

Fig. 176: Decomposition of a vectors tern

On the base of this the result is that each unbalanced three phase system can be decomposed in 3 three phase systems which can be reduced to a separate study of three single phase circuits relative to **direct sequence**, **negative sequence** and **zero sequence** respectively.

The EN50160 standard it declares, relative to low voltage systems that “*under normal operating conditions, during each period of one week, 95% of the 10 minute mean rms values of the negative phase sequence component of the supply voltage shall be within the range 0 to 2% of the direct phase sequence component. In some areas with partly single phase or two phase connected customers’ installations, unbalanced up to about 3% at three phase supply terminal occur.*” The meter permits the measure and recording of below parameters, which are characteristics of unbalanced degree of an installations:

$$NEG\% = \frac{E_r}{E_d} \times 100 = \text{component at negative sequence}$$

$$ZERO\% = \frac{E_0}{E_d} \times 100 = \text{component at zero sequence}$$

where:

$E_r$  = sequence of negative tern

$E_d$  = sequence of direct tern

$E_0$  = sequence of zero tern

### 10.9. VOLTAGE FAST TRANSIENTS (SPIKES)

The meter considers all the phenomena associated to the phase voltage as voltage spikes which have the following properties:

- **Fast slope variations of voltage waveforms.**
- **Exceeding a limit threshold fixed by user before starting a recording.**

The maximum number of recorded events in a half period (10ms @ 50Hz, 8.3ms @ 60Hz) is **4**. The maximum number of recorded events by meter during a recording is **20000**.

To better understand the features of this analysis refer to the following picture where a typical voltage spike at 50Hz frequency is shown:

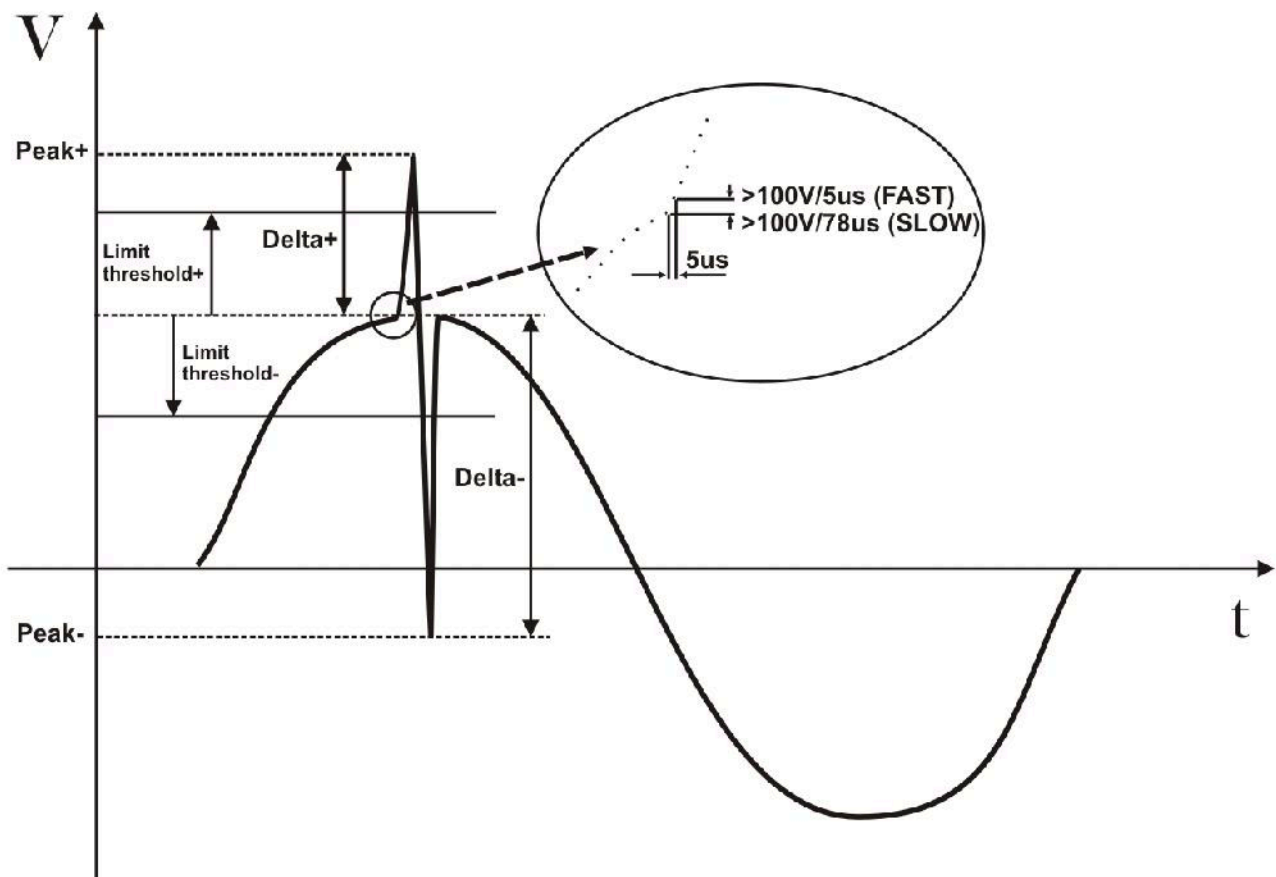

Fig. 177: Typical voltage spikes at 50Hz frequency

The meter continuously checks the input voltage signals performing 2 simultaneous routines with different sampling rates. In particular:

- **SLOW:** The signals of input voltage are sampled with a 256 samples/period rate (20ms @ 50Hz, 16.7ms @ 60Hz).
- **FAST:** The signals of input voltage are sampled at 200kHz frequency.

As soon as an event occurs, the meter automatically checks whether one of the following conditions are respected:

- $dV/dt > 100V/5\mu s \rightarrow$  type of event **FAST**.
- $dV/dt > 100V/78\mu s \rightarrow$  type of event **SLOW @ 50Hz**.
- $dV/dt > 100V/65\mu s \rightarrow$  type of event **SLOW @ 60Hz**.

and that during the **detectable time interval** defined as:

- $32 \times 5\mu\text{s} = 160\mu\text{s}$ .
- $32 \times 78\mu\text{s} = 2.5\text{ms}$ .
- $32 \times 65\mu\text{s} = 2.1\text{ms}$ .

the positive and negative difference (defined **DELTA+** and **DELTA-** respectively) it's over the "windows" defined by the limit threshold set by user.

Based to the above description, downloading the saved data from meter to PC using the standard TopView software, the below parameters are shown:

- **Num. Tot** → Total number of recorded events.
- **Limit** → Voltage value threshold defined by user which permits the recording of a event.
- **Phase** → ID of phase where the event is occurred.
- **Date/Time** → Date/Hour in minutes, seconds, cents per second when the event is occurred.
- **Up/Down** → This flag is **UP** if the spike is correspondent to a rising edge and is **DOWN** if the spike is correspondent to a falling edge.
- **PEAK+** → Max positive value reached from spike during the detectable time interval.
- **PEAK-** → Mix negative value reached from spike during the detectable time interval.
- **DELTA+** → Max positive relative difference reached from spike during the detectable time interval.
- **DELTA-** → Min negative relative difference reached from spike during the detectable time interval.
- **F/S** → Type of event (F = FAST, S = SLOW).

**For any detail about saved data please refer to TopView HELP ON LINE feature.**



### 10.10. POWER AND POWER FACTOR: DEFINITIONS

In a standard electrical installation powered by three sine voltages the following are to be defined:

Phase Active Power:	(n=1,2,3)	$P_{actn} = V_{nN} \cdot I_n \cdot \cos(\varphi_n)$
Phase Apparent Power:	(n=1,2,3)	$P_{appn} = V_{nN} \cdot I_n$
Phase Reactive Power:	(n=1,2,3)	$P_{reactn} = \sqrt{P_{appn}^2 - P_{actn}^2}$
Phase Power Factor:	(n=1,2,3)	$P_{Fn} = \frac{P_{actn}}{P_{appn}}$
Total Active Power:		$P_{act} = P_{act1} + P_{act2} + P_{act3}$
Total Reactive Power:		$P_{react} = P_{react1} + P_{react2} + P_{react3}$
Total Apparent Power:		$P_{app} = \sqrt{P_{act}^2 + P_{react}^2}$
Total Power Factor:		$P_F = \frac{P_{act}}{P_{app}}$

where:

$V_{nN}$  = RMS value of voltage between phase n and Neutral.

$I_n$  = RMS value of n phase current.

$\varphi_n$  = Phase angle between voltage and current of n phase.

In the presence of distorted voltages and currents the previous relations vary as follows:

Phase Active Power:	(n=1,2,3)	$P_{actn} = \sum_{k=0}^{\infty} V_{kn} I_{kn} \cos(\varphi_{kn})$
Phase Apparent Power:	(n=1,2,3)	$P_{appn} = V_{nN} \cdot I_n$
Phase Reactive Power:	(n=1,2,3)	$P_{reactn} = \sqrt{P_{appn}^2 - P_{actn}^2}$
Phase Power Factor:	(n=1,2,3)	$P_{Fn} = \frac{P_{actn}}{P_{appn}}$
Distorted Power Factor	(n=1,2,3)	$dPF_n = \cos \varphi_{1n}$ = phase displacement between the fundamentals of voltage and current of n phase
Total Active Power:		$P_{act} = P_{act1} + P_{act2} + P_{act3}$
Total Reactive Power:		$P_{react} = P_{react1} + P_{react2} + P_{react3}$
Total Apparent Power:		$P_{app} = \sqrt{P_{act}^2 + P_{react}^2}$
Total Power Factor:		$P_F = \frac{P_{act}}{P_{app}}$

where:

$V_{kn}$  = RMS value of kth voltage harmonic between n phase and Neutral.

$I_{kn}$  = RMS value of kth current harmonic of n phase.

$\varphi_{kn}$  = Phase displacement angle between kth voltage harmonic and kth current harmonic of n phase.

**Note:**

It shall be noted that the expression of the phase Reactive Power with no sine waveforms, would be wrong. To understand this, it may be useful to consider that both the presence of harmonics and the presence of reactive power produce, among other effects, an increase of line power losses due to the increased current RMS value. With the above given relation the increasing of power losses due to harmonics is added to that introduced by the presence of reactive power. In effect, even if the two phenomena contribute together to the increase of power losses in line, it is not true generally that these causes of power losses are in phase between each other and therefore that can be summed mathematically. The above given relation is justified by the relative simplicity of its calculation and by the relative discrepancy between the value obtained using this relation and the true value. It shall also be noted, how, in case of an electric installation with harmonics, another parameter called distorted Power Factor (Cosphi) is defined. In practice, this parameter represents the theoretical limit value that can be reached for Power Factor if all the harmonics could be eliminated from the electric installation.

### 10.10.1. Conventions on powers and power factors

As for the recognition of the type of reactive power, of the type of power factor and of the direction of the active power, the below conventions must be applied. The stated angles are those of phase-displacement of the current compared to the voltage (for example, in the first panel the current is in advance from  $0^\circ$  to  $90^\circ$  compared to the voltage):

Equipment under test = Inductive Generator ←	$90^\circ$	→ Equipment under test = Capacitive Load
$180^\circ$		$0^\circ$
Pact+ = 0    Pact- = <b>Pact</b> Pfc+ = -1    Pfc- = -1 Pfi+ = -1    Pfi- = <b>Pf</b> PreactC+ = 0    PreactC- = 0 Preacti+ = 0    Preacti- = <b>Preact</b>		Pact+ = <b>Pact</b> Pact- = 0 Pfc+ = <b>Pf</b> Pfc- = -1 Pfi+ = -1    Pfi- = -1 PreactC+ = <b>Q</b> PreactC- = 0 Preacti+ = 0    Preacti- = 0
Pact+ = 0    Pact- = <b>Pact</b> Pfc+ = -1    Pfc- = <b>Pf</b> Pfi+ = -1    Pfi- = -1 PreactC+ = 0    PreactC- = <b>Preact</b> Preacti+ = 0    Preacti- = 0		Pact+ = <b>Pact</b> Pact- = 0 Pfc+ = -1    Pfc- = -1 Pfi+ = <b>Pf</b> Pfi- = -1 PreactC+ = 0    PreactC- = 0 Preacti+ = <b>Preact</b> Preacti- = 0
	$270^\circ$	
Equipment under test = Capacitive Generator ←		→ Equipment under test = Inductive Load

where:

Symbol	Description	Remarks
Pact+	Value of the active power +	Positive parameter (user)
Pfc+	Capacitive power factor +	
Pfi+	Inductive power factor +	
Preactc+	Value of the capacitive reactive power +	
Preacti+	Value of the inductive reactive power +	
Pact-	Value of the active power -	Negative parameter (generator)
Pfc-	Capacitive power factor -	
Pfi-	Inductive power factor -	
Preactc-	Value of the capacitive reactive power -	
Preacti-	Value of the inductive reactive power -	

Value	Description
-------	-------------

Pact	The active power (positive or negative) is defined in the panel and therefore acquires the value of the active power in that moment.
Preact	The reactive power (inductive or capacitive, positive or negative) is defined in the panel and therefore acquires the value of the reactive power in that moment.
Pf	The power factor (inductive or capacitive, positive or negative) is defined in the panel and therefore acquires the value of the power factor in that moment.
0	The active power (positive or negative) or the reactive power (inductive or capacitive, positive or negative) is NOT defined in the panel and therefore acquires a null value.
-1	The power factor (inductive or capacitive, positive or negative) is NOT defined in the panel.

### 10.10.2. Three phase 3 wire ARON system

In the electrical systems distributed without neutral, the phase voltages and the power factors and phase  $\cos\phi$  lose importance. Only the phase to phase voltages, the phase currents and the total powers remain defined.

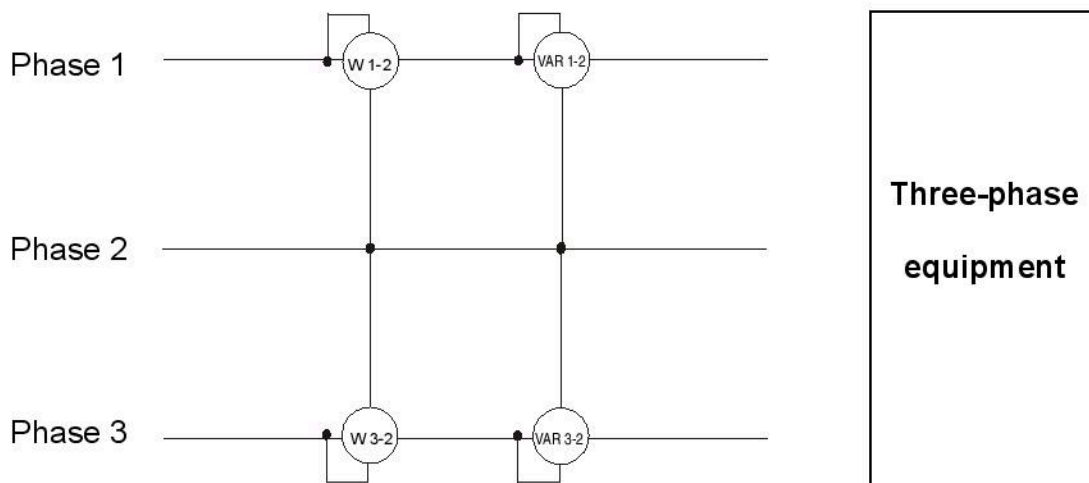

In this case the potential of one of the three phases (for example, phase 2) is taken on as reference potential. The total values of the active, reactive and apparent power are expressed as sum of the indications of the couples of Wattmeters, VARmeters and VAmeters.

$$P_{act} = P_{act12} + P_{act32}$$

$$P_{react} = P_{react12} + P_{react32}$$

$$P_{app} = \sqrt{(P_{act12} + P_{act32})^2 + (P_{react12} + P_{react32})^2}$$



## 10.11. MEASURING METHOD: OUTLINES

The meter is capable of measuring: voltages, currents, active powers, inductive and capacitive reactive powers, apparent powers, inductive and capacitive power factors, energies, analogical or pulse parameters. All these parameters are analysed in a digital way for each phase (voltage and current) and calculated based on formulas of the previous sections.

### 10.11.1. Integration period

The storage of all the data would require a huge memory capacity. Therefore we've tried to find out a storage method which permits to compress the information to be saved providing significant data.

The selected method is the integration one: after a certain period called "**integration period**", which can be set from **1 seconds to 60 minutes**, the meter extracts from the sampled values the following values:

- MINIMUM value of the parameter during the integration period (harmonics excluded)
- AVERAGE value of the parameter (intended as arithmetic average of all the values recorded during the integration period)
- MAXIMUM value of the parameter during the integration period (harmonics excluded)

Only this information (repeated for each parameter to be stored) are saved in the memory along with starting time and date of the integration period.

Once these data are stored, the instrument restarts to take measurements for a new period.

### 10.11.2. Power factor calculations

According to the standards in force, the medium power factor cannot be calculated as average of the instantaneous power factors. It must be obtained from the medium values of active and reactive power.

Each single medium power factor (of phase or total) is therefore calculated, at the end of each integration period, on the medium value of the corresponding powers independently of the fact that they must be registered or not.

Besides, for a better analysis of the type of load present on the line and in order to get reference terms in the invoicing analysis of the low  $\cos\varphi$ , the values of inductive and capacitive  $\cos\varphi$  are treated as independent parameters.

## 11. AFTER-SALE SERVICE

### 11.1. WARRANTY

This instrument is guaranteed against any defects in material and manufacturing, in compliance with the general sale terms and conditions. During the warranty period all defective parts may be replaced, but the manufacturer reserves the right to repair or replace the product.

If the instrument is to be returned to the after-sale service or to a dealer, its transport expenses must be borne by the customer. Shipment shall be however agreed upon.

A report must always accompany the returned product, stating the reasons of its return.

For shipping the instrument, exclusively use the original packaging material; any damage that may be due to non-original packing shall be charged to the customer.

The manufacturer disclaims any responsibility for damages caused to people and/or objects.

Guarantee is not applied in the following cases:

- Any repair and/or replacement of accessories and the battery (not covered by the guarantee).
- Any repair that might be necessary as a consequence of a misuse of the instrument or of its use with non compatible devices.
- Any repair that might be necessary as a consequence of improper packaging.
- Any repair that might be necessary as a consequence of service interventions carried out by unauthorised personnel.
- Any change to the instrument carried out without the express authorisation of the manufacturer.
- Use not provided for among the instrument specifications or in the instruction manual.

The content of this manual cannot be reproduced in any form whatsoever without express authorisation of the manufacturer.

**All our products are patented and their trade marks registered. The manufacturer reserves the right to modify the product specifications and price, if this is aimed at a technological improvement.**

### 11.2. SERVICE

If the instrument does not operate properly, before contacting the after-sale service check the cables and the test leads and replace them, if necessary. Should the instrument still operate improperly, check that the operation procedure is correct and corresponds to the instructions given in this manual. If the instrument is to be returned to the after-sale service or to a dealer, its transportation is on the customer's behalf. Shipment shall be however agreed upon. A report must always accompany the returned product, stating the reasons of its return. For shipping the instrument, exclusively use the original packaging material; any damage that may be due to non-original packing shall be charged to the customer.







**HT INSTRUMENTS SA**

C/ Legalitat, 89  
08024 Barcelona - **ESP**  
Tel.: +34 93 408 17 77, Fax: +34 93 408 36 30  
eMail: info@htinstruments.com  
eMail: info@htinstruments.es  
Web: www.htinstruments.es

**HT INSTRUMENTS USA LLC**

3145 Bordentown Avenue W3  
08859 Parlin - NJ - **USA**  
Tel: +1 719 421 9323  
eMail: sales@ht-instruments.us  
Web: www.ht-instruments.com

**HT ITALIA SRL**

Via della Boaria, 40  
48018 Faenza (RA) - **ITA**  
Tel: +39 0546 621002  
Fax: +39 0546 621144  
eMail: ht@htitalia.it  
Web: www.ht-instruments.com

**HT INSTRUMENTS GMBH**

Am Waldfriedhof 1b  
D-41352 Korschenbroich - **GER**  
Tel: +49 (0) 2161 564 581  
Fax: + 49 (0) 2161 564 583  
eMail: info@ht-instruments.de  
Web: www.ht-instruments.de

**HT INSTRUMENTS BRASIL**

Rua Aguaçu, 171, bl. Ipê, sala 108  
13098321 Campinas SP - **BRA**  
Tel: +55 19 3367.8775  
Fax: +55 19 9979.11325  
eMail: vendas@ht-instruments.com.br  
Web: www.ht-instruments.com.br

**HT ITALIA CHINA OFFICE**

**意大利HT中国办事处**  
Room 3208, 490# Tianhe road, Guangzhou - **CHN**  
地址：广州市天河路490号壬丰大厦3208室  
Tel.: +86 400-882-1983, Fax: +86 (0) 20-38023992  
eMail: zenglx\_73@hotmail.com  
Web: www.guangzhouht.com